

Use of density tracers in evaluating performance of Tri-Flo circuits Case study: Tabas (Iran) coal preparation plant

M. Noori and R. Dehghan*

Faculty of Mining and Metallurgical Engineering, Yazd University, Yazd, Iran

Received 20 November 2018; received in revised form 28 December 2018; accepted 6 January 2019

Keywords

Tri-Flo

Density Tracer

Separation Efficiency

Cut Point

Yield

Abstract

In the Tabas coal preparation plant (SE Iran), -50 + 6 mm raw coal was treated in a 700 mm two-stage two-density Tri-Flo dynamic dense medium separator. In order to study the circuit performance and to evaluate the separator efficiency, 32 mm cubic density tracers were used in the range of 1.28-2.1 g/cm³ and under different operational conditions. The performance of Tri-Flo was evaluated in a rapid manner, and an acceptable partitioning performance was observed under the process regime; the misplacements were in the normal range. Contrary to the dense media cyclones where the cut point shift (CPS) is usually positive, the results of this work showed that CPS was negative in both stages of the Tri-Flo separator. The Ecart probable value for the first stage of the separator ($E_{pf} = 0.023$) was rather greater than the second stage ($E_{ps} = 0.018$), representing the higher performance achieved in the second stage. In addition, the Tri-Flo operational parameters were found to be adjustable on the basis of raw coal specifications in order to reach good metallurgical results. Therefore, the optimum operational feed capacities of the Tri-Flo separator were determined to be in the range of 80-140 t/h, depending on the type of raw coal.

1. Introduction

Dense medium separation is the most efficient process for treating coal in the size range of -50 + 0.5 mm [1-4]. In this process, particles of mixed sizes, shapes, and densities are separated based on different settling rates in a dense medium suspension consisting of micronized magnetite and water. Among various dense medium devices, the dynamic separators like Dense Medium Cyclone, Dynawhirpool, and Larcodems have become more famous because of their suitable separation sharpness, especially in cleaning coals with a high amount of a near gravity material [5-7]. The last generation among dynamic heavy medium separators is a multi-stage device called Tri-Flo, which has achieved satisfying separations in the treatment of chromite, potash, barite, and particularly, coal washeries whose feed/dense media properties fluctuate very often [5, 8-11].

In an operating dense medium separator, it is normal to evaluate the separation performance by means of partition curves. A partition curve relates the partition coefficient, i.e. percentage of the feed material of a particular specific gravity that reports the floats product, to the specific gravity [12]. This data is gathered by sampling the sink and float products and performing the heavy liquid tests to determine the amount of material in each density fraction. Traditional float and sink analysis for constructing a partition curve is both expensive and time-consuming, and unfortunately, the test results become ready so late to rectify the problems in the circuit [13, 14]. Today, the use of density tracers has been accepted as an alternative technique to accurately define partition curves in coal washing dense medium circuits. The most important advantages of the tracer technique refer

to its ease of procedure and the speed of acquisition of results [15, 16].

Although there are a lot of surveys conducted by researchers in studying the performance of coal processing equipment like jig, water only cyclone, spiral, dense medium bathe/cyclone, reflux classifier, etc. using density tracers in the pilot and industrial scales [13, 17-20], there are a few reported results referring to circuits including the Tri-Flo separator. The advantages of implementation of the two-stage-in-one dense medium cylindrical vessel, Tri-Flo, have been reported by many researchers [5, 9, 11, 21]. The main advantages of coal applications include multiple products from one vessel, compact layout and capital savings, larger feed top size, less sensitivity to feed changes (both characteristics and throughput capacity), and minimal wear inside the vessel. Dehghan and Aghaei (2014) have evaluated the efficiency of the Tri-Flo separators in both coarse and small circuits in the same plant [22]. They reported the E_p values extracted from the float-sink experiments on separator products, and reported that 700 mm Tri-Flo worked worse than predicted but 500 mm of Tri-Flo's worked better compared to the supplier's E_p numbers. They did not point to the operational parameters like medium densities or feed tonnages during their study. In this work, the performance data of an industrial Tri-Flo dense medium separator treating coarse coal in a 300 t/h plant was investigated. The aim of this work was to achieve a better understanding of the Tri-Flo behavior under different operating regimes using the density tracers.

2. Materials and methods

2.1. Plant process description

The experiments were conducted at the Tabas Parvadeh coal preparation plant, located in the east-central part of Iran. The plant was commissioned in 2007 to eliminate impurities of coal excavated from Parvadeh C1 coal seam and produce metallurgical clean coal for the national steel industry. The annual capacity of the Tabas coal preparation plant is 750000 ton clean coal containing 10.5% ash (air-dried basis). As shown in Figure 1, the run of mine coal enters the screen house, and is divided into three different streams. In the coarse coal section, the coal enters a Tri-Flo with 700 mm diameter, and is exposed to media having 1.8 and 1.6 g/cm^3 specific gravities. The rejects and clean coal immediately exit the plant but the middling stream enters a small crusher (cage mill) to be crushed and resent to screen house. In a small coal section, the coal enters two Tri-Flo's with 500 mm diameter and is exposed to a medium with 1.8 g/cm^3 specific gravity. The rejects immediately exit the plant but the clean coal enters the Screen Bowl Centrifuges (SBC) for dewatering. In the fine coal section, the material enters 5 column flotation cells with diameter of 4.3 m and height of 8 m and is exposed to air bubbles made by SlamJet spargers. The overflow is sent to SBC's for dewatering, which recovers a cake, and an effluent containing most of the water and ultrafine particles (-50 micron) that returns to another flotation cell. The flotation tailing goes to a 40 m thickener, and its underflow is dewatered with two sets of filter presses.

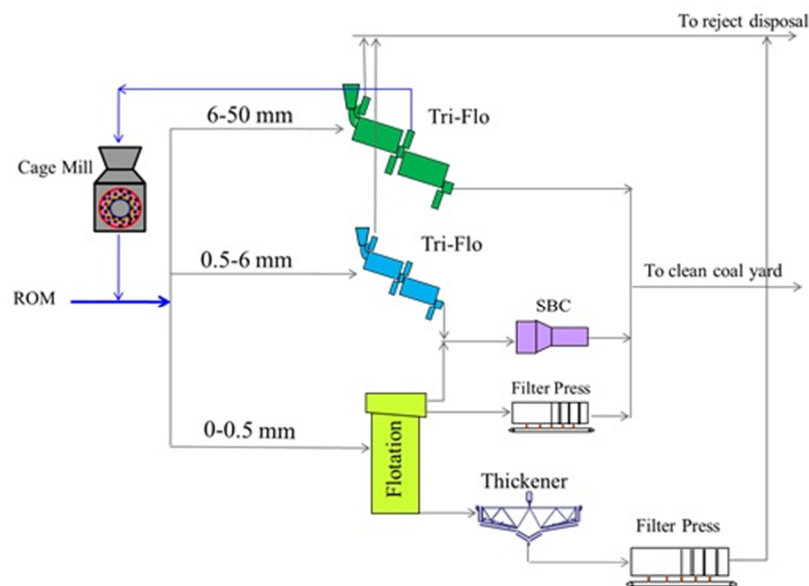

Figure 1. Process diagram of Tabas coal preparation plant.

2.2. Materials

The 700 mm Tri-Flo separator combines two stages of dense medium cylindrical cyclone separation in a single unit operation installed with a horizontal slope of 20 degrees. A schematic layout of the 700 mm Tri-Flo is illustrated in Figure 2, and the geometric dimensions of the separator are listed in Table 1. The high specific gravity heavy medium enters the separator separately from the feed material in the first stage (chamber). A small amount of medium is required to flush the material inside the separator. The feed from chute enters the Dynafeed system. The required amount of medium will enter the Dynafeed and impart a first rotation to the material to be separated. The material will flow inside the first stage for a high gravity separation. The rejects exit the separator through an upper outlet (sink 1), and the first stage product is axially transferred to the second stage. An additional medium at a lower density is introduced in the second stage, and a second separation takes place. The middlings (materials with intermediate specific gravity) exit the second

stage through an upper outlet (sink 2), and the final clean coal product exits the separator through an axial outlet (float).

The magnetic separator recovers the magnetite from dilute slurry, and allows the non-magnetic solids to pass through with the majority of water. The magnetite consumption is 970 g/t of raw coal feeding to coarse and small circuits. The magnetite has a size distribution of 95%-100 μm , 80% finer than 48 μm , and its specific gravity is about 4.3 g/cm^3 . The plant has a modern medium circuit consisting of splitters, densifying hydrocyclones, magnetic separators, demagnetizing coils, and associated instruments for controlling the medium rheology while the feed characteristics or magnetite quality changes. Density tracers were supplied from Partition Enterprises Ltd in precise densities from 1.28 g/cm^3 to 2.10 g/cm^3 at increments of 0.02. They are 32 mm cubic shaped, pink-colored tracers, and the density of each tracer is indicated by engraving (Figure 3) and is accurate within $\pm 0.005 \text{ g}/\text{cm}^3$.

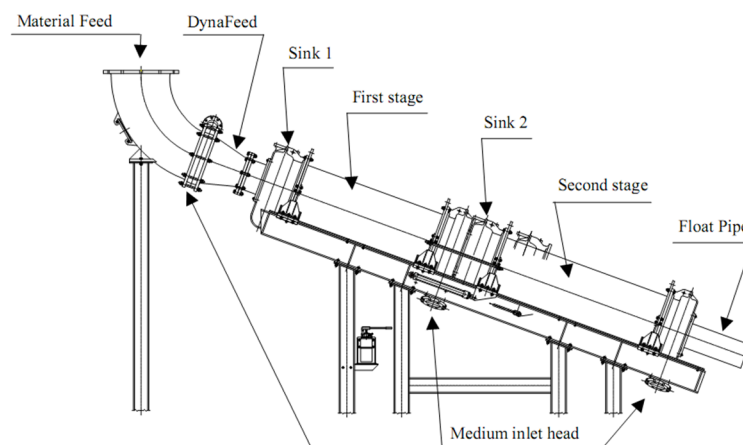

Figure 2. Schematic diagram of a Tri-Flo separator.

Table 1. Tri-Flo 700 mm dimensions.

Item	Size (mm)
Cylinders Diameter	700
1 st Stage Cylinder Length	1950
2 nd Stage Cylinder Length	2300
Feed Pipe Diameter	260
Feed Pipe Length	700
Medium Inlet Diameter	200
Discharge Outlet Diameter	200
Dynafeed Inlet Diameter	100
Orifice Diameter	210

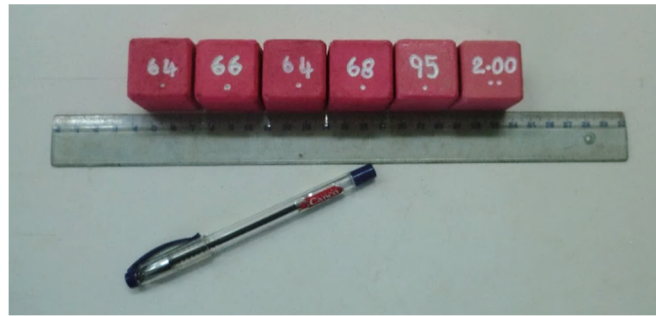

Figure 3. Cubic density tracers.

2.3. Experimental procedure

In the actual stable circuit conditions, while different types of the feed were coming into the plant, 4 tests were performed to evaluate the Tri-Flo 700 mm performance. For very low densities (-1.4 RD) and very high densities (+1.8 RD), 20 tracers were used in each density, and for the other densities, 30 tracers were used. The tracers were introduced to the separator feed chute every 3 s and were collected at the discharge end of product screens separately (reject, middling, and clean coal). 830 tracers

were added in each test, and after retrieval, they were sorted in their various densities, and the resulting data was used to plot a partition curve for each chamber of Tri-Flo. In this work, the portion of the feed tracers in each density reported to float product in each stage of the separator was calculated as the partition number. During every test, the specific gravity of heavy medium coming with each product stream was measured using a Marcy Scale density indicator. The Tri-Flo operational densities and feed tonnages to coarse circuit are given in Table 2.

Table 2. Circuit parameters during different tracer tests.

	Feed Type	Tri-Flo Feed (t/h)	High Density (g/cm ³)	Low Density (g/cm ³)
Test 1	Mechanized	170	1.80	1.55
Test 2	Mechanized	130	1.78	1.59
Test 3	Traditional 1	150	1.82	1.65
Test 4	Traditional 2	80	1.78	1.65

The performance of each coal-cleaning unit operation is characterized by a separation distribution curve, which expresses the percentage of feed reporting to clean coal product as a function of specific gravity of the particle or, in this case, tracer [23]. To assess the performance of the coarse coal circuit at the Tabas coal washing plant, only the density tracers with 32 mm size, which is a suitable size with respect to coal particles' D80 index in this circuit (29 mm), were used. The tests were performed at varying feed rates/types with various dense medium densities. Tracers were introduced into the feed stream and retrieved from the D&R screens manually. The tests were conducted only when operating under load conditions. In some tests, a few amounts of tracers (about 1%) were lost, and so they were not taken into consideration in the calculation of the partition numbers.

After the tracers' collection, they were grouped, and the number of tracers at each density class was recorded. Then the partition numbers for each stage of Tri-Flo were obtained as the number of

tracers of a density class in the float product divided by that recovered. The partition numbers were then used to plot the partition curve of the separator. This curve is normally interpreted and summarized with two separation characters [24, 25]: separation cut point (ρ_{50}) and separation efficiency (E_p). Thus the partition data is commonly fitted to the empirical models with two-parameter expressions (ρ_{50} and E_p). In this work, the equation presented by Scott and Napier-Munn was used to predict the cut point and separation efficiency [12]. As they showed, the partition curve for separations without short circuiting is approximated by:

$$P_i = 100 \left(1 - \frac{1}{1 + \exp \left[\frac{(\rho_{50} - \rho_i) \ln 3}{E_p} \right]} \right) \quad (1)$$

where P_i is the partition number, indicating the fraction with density ρ_i in the feed reporting to the float after separation, and ρ_{50} is the density of the

separation (cut-point). The performance of the separators is typically measured by E_p (Ecart probable), which is derived from the partition curve, and is calculated from:

$$E_p = \frac{\rho_{75} - \rho_{25}}{2} \quad (2)$$

where ρ_{75} and ρ_{25} are the specific gravity values, where the partition numbers are 0.75 and 0.25, respectively.

3. Results and discussion

Three different types of raw coals are processed in Tabas CPP, and their specifications are summarized in Table 3. The results of float and sink analysis conducted on 400 kg representative samples collected from the belt conveyor feeding the coarse coal circuit (Figure 4) show that selecting a two-density separation for this circuit is appropriate and allows to process high proportions of near gravity materials at high recoveries.

The size distribution curves (Figure 5) show similar particle sizes in different feed types. The figure also reveals that about 10% of particles in the coarse coal circuit are -6 mm in size and belong to the next circuit to be washed in 500 mm Tri-Flos.

The partition curves derived from the tracer tests are presented in Figures 6-9. In each graph, the

curves for both first and second stages of Tri-Flo are shown. On the graphs, the data points represent the experiment partition coefficient values obtained from density tracers, whereas the solid curves represent the fit of data to Scott & Napier-Munn model.

In Test 1, the low efficiency in the first stage of the separator is mostly due to the excessive feeding tonnage in coarse conveyor, and probably, lack of enough energy (compare with Test 2 with the same feed type) to through the sink particles out. With a look at the Tri-Flo operational settings, it was observed that the high gravity medium flow rate was 15% more in Test 2. In Test 2, separation is sharp in both the operational and metallurgical issues with respect to the feed quality. Low values of E_p in the 1st and 2nd stages indicate suitable settings in the circuit in this test.

In Test 3, the loss of five percent-1.4 g/cm³ coal particles to middlings' stream is observed. In this test, again the feed tonnage is an operational mistake in achieving suitable settings for traditional 1 mine coal. However, unlike Test 1, the second stage is under load, respecting the amount of middling and the clean coal particles inside the feed (Figure 4). Thus the second reason for not having a very good separation in this test is choosing a wrong medium density in the second stage.

Table 3. ROM properties for different feed reserves.

	Mechanized mine		Traditional mine 1		Traditional mine 2	
	Weight (%)	Ash (%)	Weight (%)	Ash (%)	Weight (%)	Ash (%)
Coarse coal	43	65.1	46	51.2	40	37.5
Small coal	35	52.6	34	33.2	43	25.7
Fine coal	22	41.8	20	38.1	17	32.1
Total feed	100	55.6	100	42.5	100	31.5
Annual portion	67%		21%		12%	
Cleaning property	easy to wash, low yield		difficult to wash, moderate yield		difficult to wash, high yield	

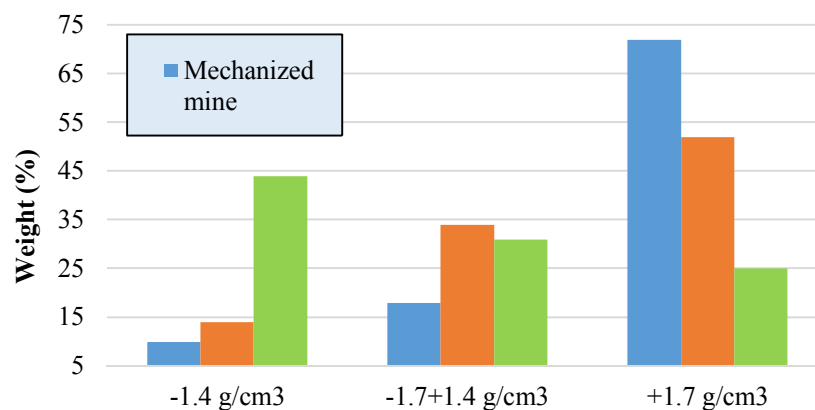

Figure 4. Comparison of three feed types of coarse coal circuit.

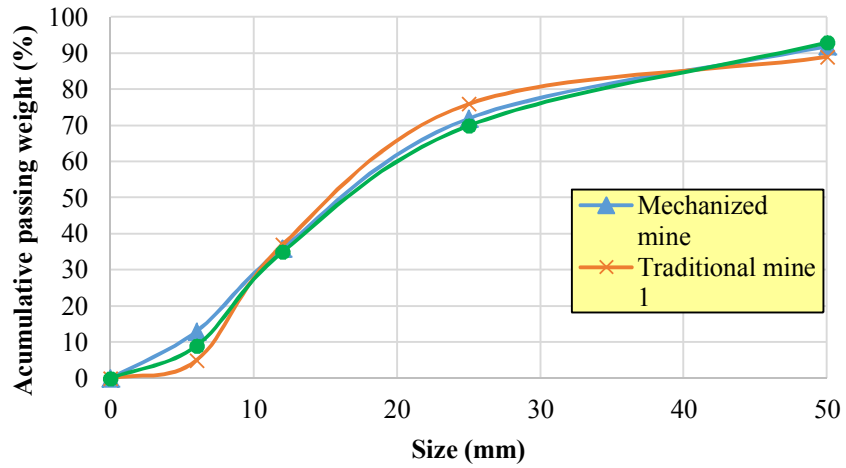

Figure 5. Size distribution of feed stream to coarse circuit.

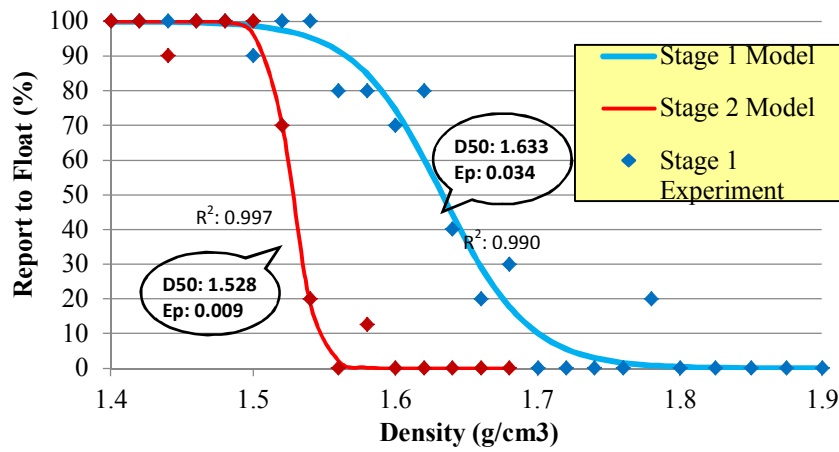

Figure 6. Partition curve of Tri-Flo in Test 1 (mechanized mine, 170 t/h).

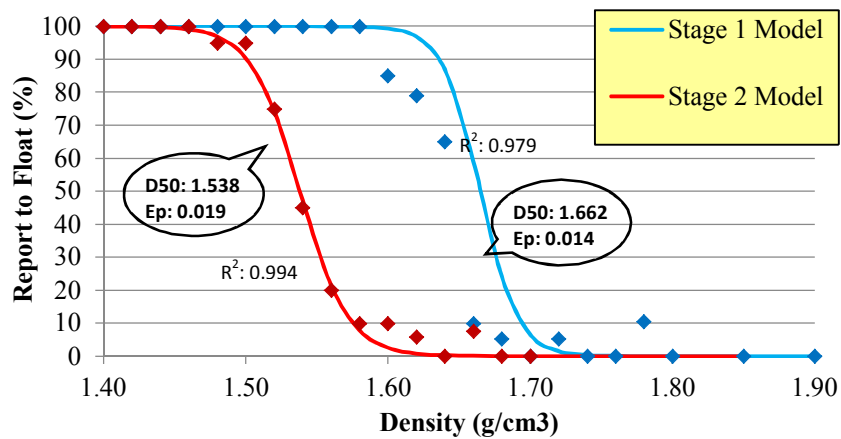

Figure 7. Partition curve of Tri-Flo in Test 2 (mechanized mine, 130 t/h).

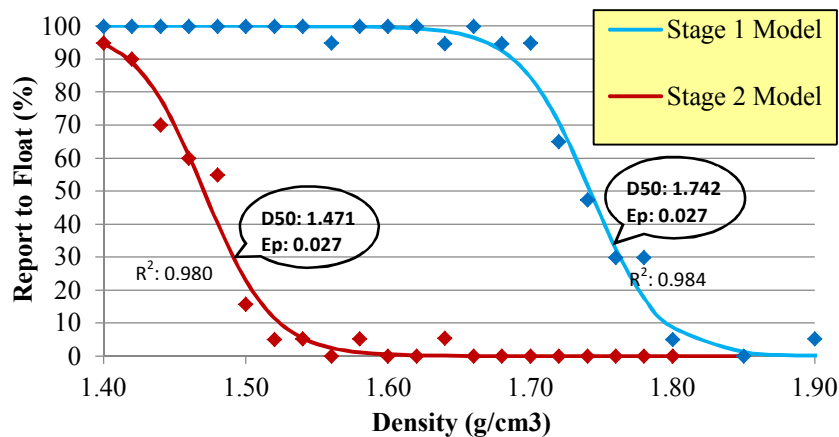

Figure 8. Partition curve of Tri-Flo in Test 3 (traditional mine 1, 150 t/h).

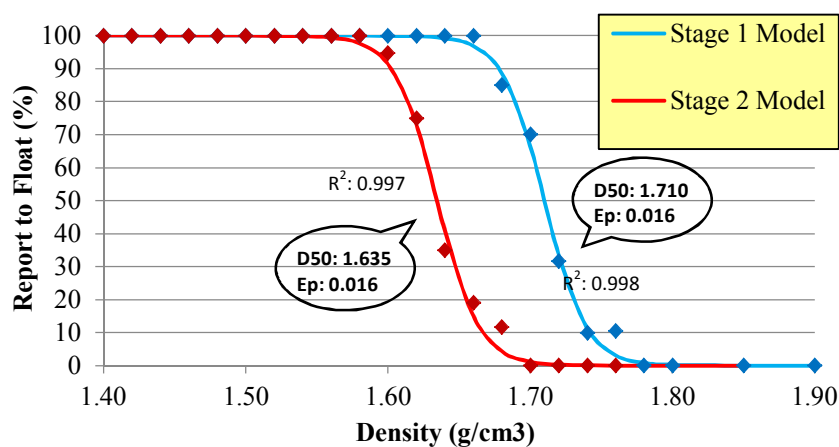

Figure 9. Partition curve of Tri-Flo in Test 4 (traditional mine 2, 80 t/h).

According to Figure 9, in Test 4, choosing very close-together densities in the first and second stages of Tri-Flo has led to very high yield (about 3 times of Test 3 and 1.5 times of Tests 1 and 2). The parameters responsible for the slope and position of both curves in Test 4 are as follow: i) lower feed tonnage (higher medium:coal ratio); ii) lower cut point shift; and iii) less medium segregation respecting density differential numbers. This test also shows that if the high and low gravity medium densities are not too different, the Tri-Flo separator will act as a Dynawhirpool without producing the third product (middling). Comparing the total masses of tracers entering the middling stream in Tests 3 and 4, it is found that the middling portion in the former is 53%, whereas, in the latter, it is only 15%.

The main characteristics of the different curves plus other associated measurements in the circuit are listed in Tables 4 and 5 for the first and second stages of Tri-Flo, respectively. In the tables, the cut point (ρ_{50}) and the separation efficiency (Ep) are obtained from the model fitted on the data but

the yield and misplaced material are calculated based on the tracer counting. The yield is the weight of all floated tracers divided by the weight of the total tracers entering each stage, and the misplaced material is the weight of misplaced tracers comparing the cut point density in each stage.

With a look at the cut point shift values in Tables 4 and 5, it can be found that, unlike dense medium cyclones, in some cases, the cut point shift ($\rho_{50} - \rho_m$) is negative in the Tri-Flo separator. The reason is that prevailing medium flow inside the Tri-Flo is outward to sink discharge head, and so the light particles must move against the prevailing flow of medium, and therefore, require a positive buoyancy to reach the float discharge. Thus any particle that finds an equilibrium orbit in Tri-Flo must be lighter than the medium (the particles on equilibrium orbits define the cut point).

In Figure 10, the Ep values have been compared with the guaranteed numbers presented by the separator supplier. Ep in the first stage varies from 0.014 to 0.034, and differs from 0.009 to 0.027 for

the second stage, which all reveal that Tri-Flo has achieved a suitable separation with a good efficiency.

The total yield, i.e. weight of floated tracers divided by weight of all recovered tracers, is calculated for the four tests, which are 34.4, 30.1, 14.4, and 45.5 percent from Test 1 to Test 4, respectively. The variations in the total yield values against difference of cut points of stage 1 and stage 2 of Tri-Flo is presented in Figure 11, showing the decrease in the total yield with increase in the difference between cut points.

The density differential values for both stages are also compared in Figure 12. The higher differentials in the second stage implies more magnetite segregation in this stage, which is reasonable considering a longer cylinder in this stage compared to the first one.

If the partition curve is drawn based on normalized density (ρ/ρ_{50}), it represents the partitioning behavior of the separator, waiver of cut point position on the curve. Figure 13 shows the normalized partition curves related to the feed tonnage to the Tri-Flo. The curves reveal that there is an optimum range for feeding capacity in which the Tri-Flo works properly. In fact, the raw coal tonnage on the coarse circuit conveyor

should not exceed 140 t/h, which is lower than the guarantee figures provided by the device supplier. Although the use of Tri-Flo in the coal processing plants is growing, the performances of its industrial units have not been reported as much in the literature as separators like dense medium cyclone, bath or drum. Since evaluating the performance of heavy medium separators via density tracers has been a cheap and easy task, different technical issues in the industrial scale would be clear with this technique. It is obvious that a detailed information about the fundamental separation principles should be gathered using the conventional float and sink technique. Similarly, Aghaei (2013) has evaluated the performance of coarse coal Tri-Flo in the Tabas coal washing plant based on the float and sink tests on coal samples [26]. He evaluated the variation in E_p for different particle sizes, while the separator was fed by a coal blend consisting of mechanized mine and traditional mine 1. In his work, the E_p values have been reported as 0.070, 0.045, 0.035, and 0.020 for particles having the sizes -6 mm, 6-12 mm, 12-25 mm, and 25-50 mm, respectively. According to his results, this study shows that the 32 mm tracers represent the behavior of particles in the range of -50 + 12 mm.

Table 4. Performance results for the first stage of Tri-Flo.

	Medium density (g/cm^3)	Cut point (g/cm^3)	E_p	Yield (%)	Cut point shift ($\rho_{50}-\rho_m$) g/cm^3	Misplaced material (%)
Test 1	1.80	1.633	0.034	55.9	-0.167	8.5
Test 2	1.78	1.662	0.014	53.4	-0.118	2.8
Test 3	1.82	1.742	0.027	67.8	-0.078	6.6
Test 4	1.78	1.710	0.016	60.8	-0.070	4.0

Table 5. Performance results for the second stage of Tri-Flo.

	Medium density (g/cm^3)	Cut point (g/cm^3)	E_p	Yield (%)	Cut point shift ($\rho_{50}-\rho_m$) g/cm^3	Misplaced material (%)
Test 1	1.55	1.528	0.009	61.5	-0.022	2.8
Test 2	1.59	1.538	0.019	56.5	-0.052	6.0
Test 3	1.65	1.471	0.027	21.2	-0.179	9.4
Test 4	1.65	1.635	0.016	74.8	-0.015	4.0

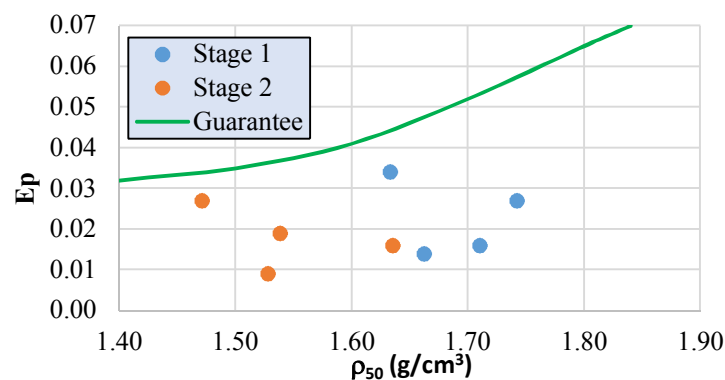

Figure 10. Comparison of experimental E_p 's with guaranteed values.

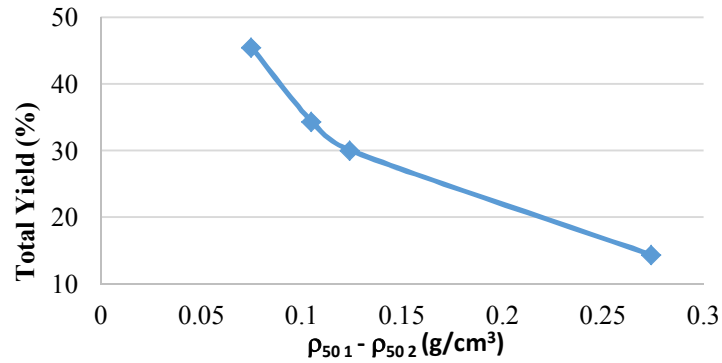

Figure 11. Variation in total yield with cut points' difference.

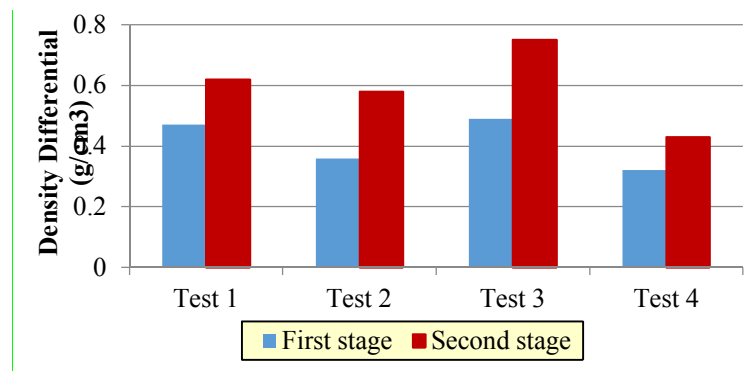

Figure 12. Comparison of density differentials in the conducted tests.

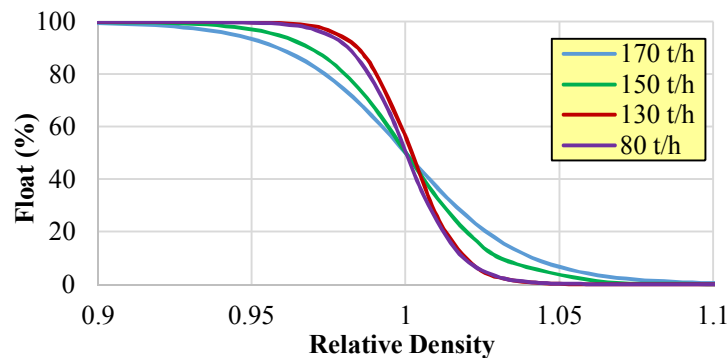

Figure 13. Normalized partition curves in the conducted tests.

4. Conclusions

The separation characteristics of the coarse coal circuit in the Tabas coal preparation plant were successfully determined using 32 mm density tracers in a 700 mm Tri-Flo separator. Although the E_p values for 4 tests based on feed capacity were satisfactorily low in the range of 0.009-0.034, the main inefficiencies distinguished in the tests were due to high feed tonnage and inappropriate density selection (with respect to the feed type). Unlike the reported figures for dense medium cyclone, the cut point shift (effective cut density in comparison with correct medium) was negative in the Tri-Flo separator. The results of calculating the total yield based on tracer counting showed that decreasing the difference between the first and second cut points would increase the total

clean coal yield. The tracer results have a good agreement with the previous survey conducted by traditional float and sink analysis on the coal particles coarser than 12 mm.

Acknowledgments

The financial support of the Tabas Parvadeh Coal Company is appreciated. Our especial acknowledgments also goes to Ramezan Koriti, Ali Jarahi, and Majid Sabeghi for their kind helps and useful suggestions.

References

- [1]. Davis, J.J. (1987). A study of coal washing dense medium cyclones. PhD Thesis, University of Queensland, Australia, 123 P.

- [2]. Hu, S., Firth, B., Vince, A. and Lees, G. (2001). Prediction of dense medium cyclone performance from large size density tracer test. *Minerals Eng.* 14 (7): 741-751.
- [3]. Suresh, P.D., Kumar, V., Sripriya, R., Chakraborty, S. and Meikap, B.C. (2010). Performance characteristics of pilot plant dense media hydrocyclone for beneficiation of coal and 3-D simulation. *Chemical Eng. Sci.* 65 (16): 4661-4671.
- [4]. Napier-Munn, T. (2018). The dense medium cyclone- past, present and future. *Minerals Eng.* 116: 107-113.
- [5]. Burton, M.W.A., Ferrara, G., Machiavelli, G., Porter, M.M. and Ruff, H.J. (1991). The economic impact of modern dense medium systems. *Minerals Eng.* 4 (3-4): 225-243.
- [6]. Ferrara, G. (1995). State-of-the-art and new developments in dense medium separation processes. *Mineral processing: recent advances and future trends. Proc, Conference honoring professor P. C. Kapur, Indian institute of technology, Kanpur, 11-15 December.* pp. 311-331.
- [7]. Ferrara, G., Bozzato, P. and Chine, B. (1999). Performance of conical and cylindrical separatory vessels in dynamic dense medium separation processes. *Minerals & Metallurgical Pro.* 16 (2): 8-15.
- [8]. Ferrara, G., Machiavelli, G., Bevilacqua, P. and Meloy, T.P. (1994). Tri-Flo: A multistage high-sharpness DMS process with new applications. *Minerals & Metallurgical Pro.* pp. 63-73
- [9]. Bozzato, P., Peng, F.F. and Gu, Z. (2005). Dense medium Tri-Flo separator: A review and new development. *SME annual meeting, Littleton.*
- [10]. Bevilacqua, P., Albini, L., Gandolfi, P.B. and Bozzato, P. (2006). A new flushing system for cylindrical dense medium separators. *Proc, 23rd Intl Mineral Processing Congress, Istanbul, Turkey, 3-8 September.* pp. 357-362.
- [11]. Bozzato, P. (2007). Discards and low quality ROM washing an update on Tri-Flo separator, SIMA, India.
- [12]. Napier-Munn, T. (2006). Dense medium separation. In: Wills, B.A. and Napier-Munn, T. (Eds.). *Mineral Processing Technology.* 7th ed., Butterworth Heinemann Publisher, UK. pp. 246-266.
- [13]. Davis, J.J., Wood, C.J. and Lyman, G.J. (1985). The use of density tracers for the determination of dense medium cyclone partition characteristics. *Coal Prep.* 2: 107-125.
- [14]. De Korte, G.J. (2003). Comments on the use of tracers to test dense medium plant efficiency. *Coal Prep.* 23: 251-266.
- [15]. Wood, C.J. (1990). A performance model for coal-washing dense medium cyclones. PhD Thesis, University of Queensland, Australia, 202 P.
- [16]. Lyman, G.J., Vanlatum, L.A., Jonkers, A. and Hughes, D.M. (1991). Density tracers as a tool in coal preparation. *Coal Prep.* 9: 65-84.
- [17]. Wood, C.J. (2004). Density tracer testing of coarse coal separators: Suggestions for an Australian standard. *Proc, tenth Australian Coal Preparation Conference, Membrey, WB(ed).* Paper E12.
- [18]. Macpherson, S.A., Iveson, S.M. and Galvin, K.P. (2010). Density based separations in the reflux classifier with an air-sand dense-medium and vibration. *Minerals Eng.* 23: 74-82.
- [19]. Chen, J., Chu, K.W., Zou, R.P., Yu, A.B. and Vince, A. (2012). Prediction of the performance of dense medium cyclones in coal preparation. *Minerals Eng.* 31: 59-70.
- [20]. Izerdem, D., Orhan, E.C., Ozcana, O. and Alpayb, E. (2018). Application of density tracers in a dense medium circuit: A case study. *Minerals Eng.* 121: 39-46.
- [21]. Ferrara, G. and Ruff, H.J. (1982). Dynamic dense medium separation processes- further developments with particular reference to the Tri Flo separator. *Erzmetall.* 35 (6): 294-298
- [22]. Dehghan, R. and Aghaei, M. (2014). Evaluation of the performance of Tri Flo separators in Tabas (Parvadeh) coal washing plant. *Research Journal of Applied Sciences, Engineering and Technology.* 7 (3): 510-514.
- [23]. Galvin, K.P. (2006). Options for washability analysis of coal - a literature review. *Coal Prep.* 26: 209-234.
- [24]. King, R.P. (2012). Gravity separation. In: Schneider, C.L. and King, E.A. (Eds.). *Modeling and Simulation of Mineral Processing Systems.* 2nd ed., Society for Mining, Metallurgy, and Exploration, Inc. pp. 277-314.
- [25]. Galvin, K.P., Iveson, S.M. and Hunter, D.M. (2018). Deconvolution of fractionation data to deduce consistent washability and partition curves for a mineral separator. *Minerals Eng.* 125: 94-110.
- [26]. Aghaei, M. (2013). Evaluation of heavy medium circuit in Tabas coal washing plant. MS Thesis, Yazd University, Iran, 209 P.

کاربرد ردیاب‌های دانسیته در ارزیابی عملکرد مدارهای ترایفلو مطالعه موردی: کارخانه زغالشویی طبس (ایران)

مسعود نوری و رضا دهقان*

دانشکده مهندسی معدن و متالورژی، دانشگاه یزد، ایران

ارسال ۲۰۱۸/۱۱/۲۰، پذیرش ۲۰۱۹/۱/۶

* نویسنده مسئول مکاتبات: rdehghans@yazd.ac.ir

چکیده:

در کارخانه زغالشویی طبس، زغال سنگ خام با ابعاد ۵۰+۶- میلی‌متر، توسط یک دستگاه ترایفلوی دومرحله‌ای (جداکننده واسطه سنگین دینامیکی) به قطر ۷۰۰ میلی‌متر تغلیظ می‌شود. در این پژوهش، با استفاده از ردیاب‌های مکعبی ۳۲ میلی‌متری (در محدوده وزن مخصوص ۱/۲۸ تا ۲/۱۰ گرم بر سانتی‌متر مکعب) عملکرد مدار بررسی شد و خطای جدایش دستگاه مورد ارزیابی قرار گرفت. با تکنیک ردیاب‌های دانسیته، کارایی جدایش دستگاه به سرعت ارزیابی شد و نتایج نشان داد که دستگاه در محدوده شرایط عملیاتی مورد بررسی، جدایش خوبی داشته و میزان مواد به اشتباه تقسیم شده، در حد قابل قبولی است. برخلاف سیکلون‌های واسطه سنگین که انحراف دانسیته جدایش از دانسیته سیال واسطه سنگین (CPS) معمولاً مثبت است، نتایج پژوهش نشان داد که CPS در هر دو مرحله ترایفلو منفی می‌باشد. مقدار خطای احتمالی جدایش در مرحله اول دستگاه ($Ep_1=0/023$) بیشتر از مرحله دوم آن ($Ep_2=0/018$) است که نشان‌دهنده عملکرد بهتر مرحله دوم است. همچنین مشخص شد که پارامترهای عملیاتی دستگاه می‌بایست بر اساس مشخصات زغال سنگ خام ورودی به مدار تنظیم شوند تا نتایج متالورژیکی خوبی حاصل شود؛ بنابراین متناسب با نوع زغال سنگ ورودی به دستگاه، ظرفیت بهینه خوراک‌دهی برای جداکننده ترایفلو، بین ۸۰ تا ۱۴۰ تن بر ساعت تعیین شد.

کلمات کلیدی: ترایفلو، ردیاب دانسیته، کارایی جدایش، دانسیته جدایش، راندمان.