

Determination of scratching energy index for Cerchar abrasion test

M.T. Hamzaban^{1*}, H. Memarian² and J. Rostami

1. Mining Engineering Faculty, Sahand University of Technology, Tabriz, Iran
2. School of Mining Engineering, College of Engineering, University of Tehran, Tehran, Iran
3. Department of Mining Engineering, Colorado School of Mines, Denver, USA

Received 23 May 2017; received in revised form 27 July 2017; accepted 27 July 2017

*Corresponding author: hamzaban@sut.ac.ir (M.T. Hamzaban).

Abstract

Rock abrasivity is an essential factor for selecting cutting tools, estimating tool wear and life, and ultimately, matching various mechanized excavation systems with a given geologic condition. It also assists engineers to determine economic limits of different cutting tools and machines used in civil and mining projects. The Cerchar abrasion test is a simple and most widely used method for rock abrasivity assessments. However, it has some shortcomings to describe the steel-rock interaction during the cutting process. In this work, two new parameters are used to describe the pin-rock interaction in the Cerchar abrasion test and to evaluate the efficiency of the rock scratching process. A set of 41 different rock samples are tested by a newly developed testing device. The device provides a more precise control of the testing operational parameters, and measures the applied frictional force on the pin and its horizontal and vertical displacements on the sample surface. The results obtained are used to calculate the Modified Cerchar Abrasion Index (*MCAI*) and the Scratch Energy Index (*SE_i*), as two newly developed parameters. The accuracy of the calculated parameters is discussed. Our investigations show that *MCAI* has closer correlations with rock mechanical parameters than *CAI*, and therefore, has a higher potential to estimate the rock cutting tool wear in tunneling applications. Also *SE_i* shows sensible correlations with sample hardness and mechanical properties. The results obtained show that *SE_i* can be used to compare the efficiency of various pin hardnesses to create scratches on various rock samples, and could be used as a determinative parameter in selecting the cutting tool hardness.

Keywords: Cerchar Abrasion Test, Scratching Energy Index, Rock Abrasivity, Tool Wear.

1. Introduction

Various mechanical excavation systems use different tools for rock fragmentation in civil and mining applications. Similarly, various bits used in geotechnical, mining, and oil well drilling use the same general principle of application of an indenter to penetrate rocks. As a part of these operations, cutting tool wear occurs as a function of encountered rock abrasivity and its working conditions. Thus rock abrasivity is an important parameter in the assessment of tool life and estimating the related costs as well as evaluating the efficiency of operation, which directly affects the production rate.

Wear is defined as the progressive loss of material from the surface of a solid body (cutting tool) due

to a mechanical action, i.e. contact and relative motion against another solid, liquid or gaseous counter body [1]. Although abrasivity is a commonly used word, and certain rock types are considered abrasive, the related implications are not straightforward. Whether a tool is suitable for use to excavate a rock depends on the properties of rock (abrasivity/strength), properties of the cutting tool, and the working conditions such as temperature, moisture content, and pressure during the cutting process. For example, quartz is abrasive when compared to steel but not against tungsten carbide at room temperature and pressure [2]. However, this does not mean that quartz cannot wear tungsten carbide, as it surely does.

The rate of wear depends on the percentage and shape of hard minerals in the rock including quartz.

The common approach to assess the abrasivity of a rock is to perform laboratory tests in order to measure pertinent rock properties for predicting the tool wear in the field. This often involves rubbing a steel or carbide piece against the rock sample to observe the amount of weight loss due to wear in conditions that are similar to the stress and working conditions of the actual tools. Wear is most likely measured based on weight loss on the working piece.

Different tests have been developed and introduced to measure rock abrasivity. The problem with these tests is that the results obtained are highly dependent on the experience and skills of the operator and experimental conditions such as the material properties, temperature, and presence of water. On the other hand, mechanisms of the motions affect the occurred wear in the tests as well [2].

The Cerchar test is one of the simplest methods proposed to measure rock abrasivity, and is widely used for classification of rocks and estimation of cutting tool consumption in the mechanized excavation. The test was originally introduced in Laboratoire du Centre d' Etudes et Recherché des Charbonnages de France in the

1970s [3]. The first formal description of the testing method was provided in the French standard NF P 94-430-1 [4]. An ASTM standard was introduced in 2010 [5], and recently, an ISRM-suggested method has been published for the Cerchar test [6].

According to the ISRM-suggested method, a steel pin with a conical vertex of 90° and a hardness of 55HRC is placed on the rock surface under a static load of 70 N. The pin is scratched on the sample surface for a length of 10 mm. The recommended motion speed is 10 mm/s (or 1 mm/s, depending on the testing apparatus). There are three different generations of the Cerchar testing devices (Figure 1). The first generation was designed and manufactured by Cerchar Institute in France. The second-one was manufactured at the Colorado School of Mines (CSM) in the mid-80s, and the third one in the UK in 1989 [7]. Wear flatness of the pin tip created in this process is measured by a microscope. The measured value is reported in 0.1 mm and is called the Cerchar Abrasion Index (*CAI*) [6]. The test can be conducted on sawn or fresh broken rock surfaces. It is a simple and fast method, and the results are widely used to classify the rock abrasive capacity [8] and predict the consumption of rock cutting tools in excavation applications [7, 9-12].

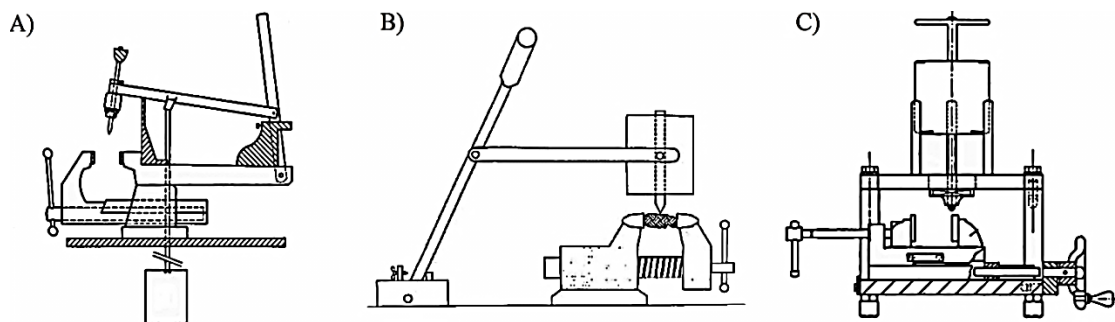

Figure 1. Schematic drawing of various versions of Cerchar Abrasion testing devices. a) original or first-generation machine by CERCHAR institute in France, b) second-generation device by CSM in the US, c) third-generation device by West in the UK [7].

Many researchers have studied the effects of various parameters on the results of the Cerchar test. It is established that there is a direct correlation between the Cerchar abrasion index (*CAI*) and the hardness of rock forming minerals [11, 14-22]. Laboratory investigations have also shown that *CAI* increases with increase in the size of rock forming grains and crystals [22-24]. Positive linear correlations between the Cerchar abrasion index and the uniaxial compression strength as well as the P-wave velocity have also been introduced [11, 17, 20-22, 25-27].

Investigations have shown that the higher the confining pressure on the specimen during the test, the greater is the Cerchar abrasion index [25]. Finally, it has been reported that *CAI* increases with increase in the sample Brazilian tensile strength (*BTS*) [21].

Other works have shown that the Cerchar abrasion index has smaller values when using harder pins [7, 10, 16, 28-30]. *CAI* on rough broken rock surfaces has greater values than smooth sawn surfaces [7, 16, 17, 22, 31-33]. Some authors have stated that the major part of the pin tip wear

occurs in the first millimeters of sliding [16, 17, 33]. However, more precise tests have shown that for highly abrasive rocks, pin tip wear continues with sliding length [13]. A direct correlation between the pin load and its tip wear has been reported [31]. However, it seems that there is no correlation between the pin sliding velocity and its tip wear [7, 31]. Finally, tests on saturated rock samples have revealed that increase in the water content and saturation could cause a sensible reduction in the *CAI* values obtained [34].

Despite the findings of the previous studies on the Cerchar test, there are still several shortcomings in performing this test in commercial laboratories. Effective parameters such as sliding length and speed are controlled by the operator. Precision and experience have considerable effects on controlling these parameters, and probably, the results obtained. The results are reported only based on the pin tip wear at the end of the test. There is no information on the progression of the pin tip wear and its penetration into the sample surface during the test. Thus the only parameter that is reflected in the results of *CAI* testing is pin tip wear at the end of the scratch, and no attention is paid to the scratch created on rock surfaces or the shape of the worn piece during the test.

Neither the Cerchar abrasion test nor other conventional testing methods provide any insight on the interaction between steel tool and rock material during the process. The outcome of abrasion tests is usually limited to the results of simple measurements on the worn parts of the testing pieces at the end of the tests, and no attention is paid to what happens to the rock samples during the test. Close examination of the pin movement and condition of the tip during the test is very important because the wear of cutting tools takes place when they penetrate the rock surface. Thus in a given rock type, the wear of cutting tools is relevant to a specific amount of penetration under constant operational conditions. This means that considering both wear and penetration is essential in evaluating a cutting process under a given condition.

The results of Cerchar tests with a new version of the testing device, which can precisely control the sliding speed and displacement, have been discussed in the previous publications by the authors [13, 35, 36]. Also a new modified Cerchar abrasion index (*MCAI*) has been introduced by the authors. In the current study, an analytical method was reviewed to calculate the changes of pin tip wear and penetration into the rock. Correlations between *MCAI* and rock properties as well as the

same correlations with *CAI* were discussed, indicating that *MCAI* was a more reliable parameter for characterization of rock abrasive properties. Calculation of an energy index for the Cerchar test and its correlation with the rock abrasivity and mechanical parameters was examined. The energy index could be useful to compare the efficiency of various cutting tools with different hardness against different rock samples. The results obtained show that the calculated energy index has a strong correlation with the rock abrasivity and increases when using softer pins. This issue is the focus of the current paper, where the measured values of the Cerchar testing parameters will be used to have a closer look at the energy index and its implications on the testing results.

2. Methodology

A new version of the Cerchar abrasion testing device has been used in the current studies. The basic design and operation of this device have been discussed by the authors in more details as a part of the previous publications [13]. The sliding distance and speed can be accurately controlled, and pin-rock frictional force as well as pin vertical displacement on the rock surface were continuously measured by the sensors. Figure 2 shows a schematic view of the testing device.

A total of 41 rock samples were tested by the new device. The *CAI* values were obtained on the sawn surface of samples according to the ISRM-suggested method using pin hardness of 55HRC (*CAI₅₅*) and 43HRC (*CAI₄₃*). The applied frictional force and pin tip horizontal and vertical displacements on the sample surface were recorded during the tests. The work or energy consumption was calculated by plotting frictional force versus sliding displacement graphs and calculating the area under these curves. This parameter was named *W₅₅* and *W₄₃* for 55 and 43HRC pins, respectively. Table 1 summarizes the results of testing the samples.

In order to verify the accuracy of the proposed analytical model to calculate the *CAI* value at any point along the sliding path, additional Cerchar tests were performed with a scratch length of 5 mm on 6 samples.

Mineralogical studies based on the thin section analysis of 17 samples were completed, and the abrasive mineral content (*AMC*) of the samples was calculated as follows [37]:

$$AMC = \sum_{i=1}^m A_i \cdot R_i \quad (1)$$

where A_i is the percentage of the i -th mineral in the rock composition (%), R_i is the ratio of the hardness of the i -th mineral to the hardness of quartz, and m is the count of minerals in the rock composition. The results of AMC calculations are also listed in Table 1. Mechanical properties of eight samples were measured. This includes uniaxial compressive strength (UCS), modulus of elasticity (E), and Brazilian tensile strength (BTS).

The results of rock mechanical tests are reported in Table 1 as well.

Moreover, the $MCAI$ (modified Cerchar abrasion index) and SE_i values were calculated for all the tested samples and reported as $MCAI_{55}$ ($MCAI_{43}$) and SE_{i55} (SE_{i43}) for 55HRC (43HRC) pins. The procedure for calculating these parameters will be discussed in the following sections.

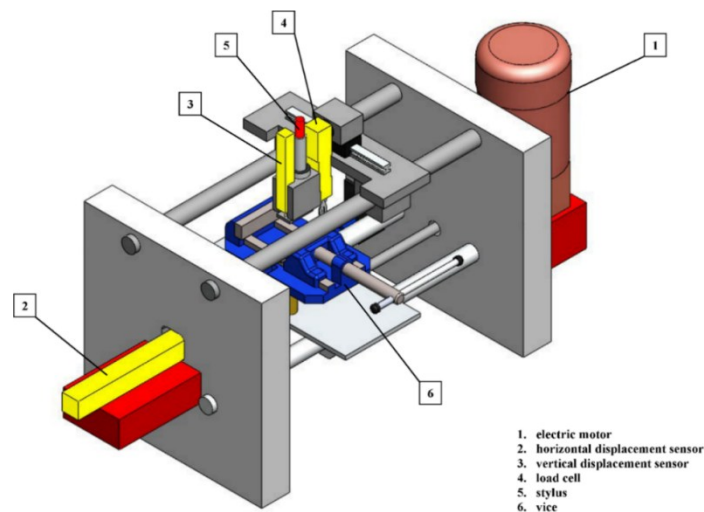

Figure 2. Schematic view of new testing device [13].

3. Analysis of test results

3.1. Modification of CAI to describe pin-rock interaction

The Cerchar abrasion index (CAI) is determined only based on the pin tip wear at the end of the test. Previous studies by the authors have shown the importance of characterizing the nature and quantity of pin penetration into the rock surface. This is due to the fact that in a real application of the cutting tools, the rock-pin interaction defines and controls the wear of tool, and any test that intends to measure rock abrasivity for tool wear prediction should reflect this interaction.

The new testing device measures and records the required horizontal force to move the pin on the rock surface (frictional force) and the pin vertical and horizontal displacement during the tests. Thus graphs of pin horizontal force ($T(x)$) and pin vertical movements ($A(x)$) versus pin horizontal displacement on the sample surface, x , can be generated. An example of such graphs is shown in Figure 3. The applied horizontal force at the end of the test (T_{ult}) can also be obtained from the graphs of $T(x)$. It has been shown that there is a direct correlation between the pin tip penetration into the rock and the applied horizontal (frictional) force [35]. A new Index has been

introduced as “Modified Cerchar Abrasion Index ($MCAI$)”, as follows [35]:

$$MCAI = \frac{CAI}{T_{ult}} \quad (2)$$

CAI is the pin tip wear at the end of the scratch. T_{ult} or applied horizontal (friction) force has a direct correlation with tip penetration into the rock surface. In hard and abrasive rocks, CAI is often high, and due to the low penetration, T_{ult} has a small value. Therefore, $MCAI$ often has a large value in hard and abrasive rocks. To the contrary, in rocks with lower hardness and abrasivity, CAI decreases and T_{ult} increases, which result in lower values of $MCAI$. The authors have shown that $MCAI$ can provide a better description of rock-pin interaction, and can be used as a more logical classification parameter to categorize various rocks based on their hardness and abrasivity [35]. However, the ultimate proof is the comparison of the tool wear in the field and the measured CAI or $MCAI$ indices to show which one is the more reliable measure to represent rock abrasion for pertinent applications. The $MCAI$ values for the 43HRC and 55HRC pins ($MCAI_{43}$ and $MCAI_{55}$, respectively) are reported in Table 1.

Table 1. Summary of testing results [13, 35].

Sample	Rock Type	CAI ₄₃ (0.1 mm)	CAI ₅₅ (0.1 mm)	W ₄₃ (Kgf.cm)	W ₅₅ (Kgf.cm)	MCAI ₅₅ (0.1mm/N)	MCAI ₄₃ (0.1mm/N)	SE _{i55} (kJ.cm ⁻³)	SE _{i43} (kJ.cm ⁻³)	AMC	UCS (MPa)	E (GPa)	BTS (MPa)
AR	marble	1.46	1.06	3.29	3.74	2.45	3.61	1.12	2.31	-	-	-	-
AR-02	fine crystalline granite	4.52	3.49	3.46	3.22	8.83	10.89	12.91	21.61	0.83	108.51	24.62	8.20
AR-04	fine crystalline granite	4.00	3.64	2.90	2.97	10.14	12.32	11.63	19.48	0.81	-	-	-
AR-07	andesite	1.45	1.26	3.76	3.43	3.20	3.10	1.63	3.01	0.48	-	-	-
AR-08	diorite	2.71	2.07	3.07	2.92	5.86	6.90	3.22	12.63	0.83	45.75	16.92	5.62
AR-10	microcrystalline limestone	1.44	0.98	3.49	4.07	2.06	3.50	1.45	3.90	0.43	-	-	-
AR-12	syenite	1.88	1.47	3.68	4.01	3.13	4.44	1.38	2.85	0.74	28.22	13.62	5.23
AR-16	pegmatite	3.35	2.28	2.95	3.43	5.81	10.20	2.00	24.31	0.77	51.77	17.43	7.43
AR-17	calcareous sandstone	1.35	0.84	3.84	4.18	1.46	2.94	1.09	2.15	0.57	-	-	-
AR-20	clayey limestone	1.55	0.92	3.16	3.97	1.78	4.08	1.08	3.75	0.43	73.90	18.04	6.37
AR-22	microcrystalline limestone	1.59	1.04	3.16	3.62	2.63	4.36	1.45	11.90	0.43	12.22	11.70	2.34
AR-26	quartzitic sandstone	2.89	2.63	1.87	2.23	7.50	8.30	5.75	7.88	0.77	44.41	16.06	7.41
AR-30	Slate	2.96	2.43	2.17	1.68	6.60	8.50	4.57	8.09	0.89	74.95	19.03	9.04
AR-31	quartz latite	2.56	2.05	1.89	2.31	4.00	11.01	1.78	22.39	0.74	-	-	-
HL	halite	0.09	0.01	4.35	4.05	0.02	5.10	0.96	6.56	-	-	-	-
MB	marble	1.46	1.13	3.12	2.91	2.79	3.56	1.92	4.94	-	-	-	-
QZ	quartzite	4.80	3.88	3.57	2.74	11.50	11.19	17.90	20.16	-	-	-	-
SL-01	clayey siltstone	0.26	0.20	4.06	3.97	0.46	0.62	0.24	0.44	-	-	-	-
SL-02	sandy limestone	1.40	0.80	4.59	5.16	1.23	2.89	0.38	1.11	-	-	-	-
SL-03	sandy limestone	1.51	0.97	3.21	2.99	3.06	4.50	3.47	2.95	-	-	-	-
SL-04	calcareous sandstone	1.23	0.96	4.65	4.66	1.91	2.35	0.88	1.21	-	-	-	-
SL-05	compacted tuff	2.45	1.61	4.59	4.37	3.21	4.85	2.00	3.15	-	-	-	-
SL-06	marl	0.57	0.33	5.55	5.81	0.50	0.87	1.09	1.41	-	-	-	-
SP-01	granite	4.74	4.13	3.17	3.08	12.40	13.50	26.97	16.94	-	-	-	-
SP-02	granite	4.78	3.96	3.13	3.23	9.75	13.46	15.28	33.40	-	-	-	-
SP-03	coarse crystalline granite	3.73	3.19	2.36	2.53	11.99	11.00	22.08	16.26	-	-	-	-
SP-04	schist	3.16	2.89	1.89	2.65	9.70	10.80	10.01	15.13	-	-	-	-
SP-05	limestone	1.13	0.85	3.72	4.73	1.58	2.51	0.93	1.48	-	-	-	-
SP-06	basalt	2.95	2.16	3.46	3.77	5.28	7.25	5.94	8.23	-	-	-	-
SP-07	sandy dolomite	1.57	0.89	3.10	3.77	2.03	4.71	0.76	8.55	-	-	-	-
UT-01	barite	1.24	0.75	3.55	3.53	1.78	3.16	0.82	1.19	0.46	-	-	-
UT-02	amphibolite	2.30	1.69	4.38	3.55	3.48	4.67	0.99	1.71	0.79	-	-	-
UT-03	tuff	0.75	0.45	4.58	5.51	0.67	1.29	0.61	1.03	-	-	-	-
UT-04	anorthosite	4.27	3.30	2.32	1.79	10.80	11.40	15.74	17.29	0.86	-	-	-
UT-06	marble	1.50	0.97	4.08	3.34	2.49	3.16	1.20	3.15	-	-	-	-
UT-07	travertine	1.50	0.84	4.48	4.60	1.51	3.20	0.79	2.46	-	-	-	-
UT-08	halite	0.15	0.16	4.08	4.28	0.33	0.31	0.92	1.07	0.36	-	-	-
UT-09	anhydrite	1.07	0.35	3.59	3.82	0.78	2.44	0.97	1.32	-	-	-	-
UT-11	limestone	1.57	0.94	4.05	3.70	2.34	3.47	0.61	1.28	-	-	-	-
UT-13	anhydrite	0.91	0.68	4.41	4.92	1.15	1.87	0.47	0.46	-	-	-	-
UT-15	microcrystalline limestone	1.51	0.98	2.50	2.51	5.00	5.11	4.27	10.92	-	-	-	-

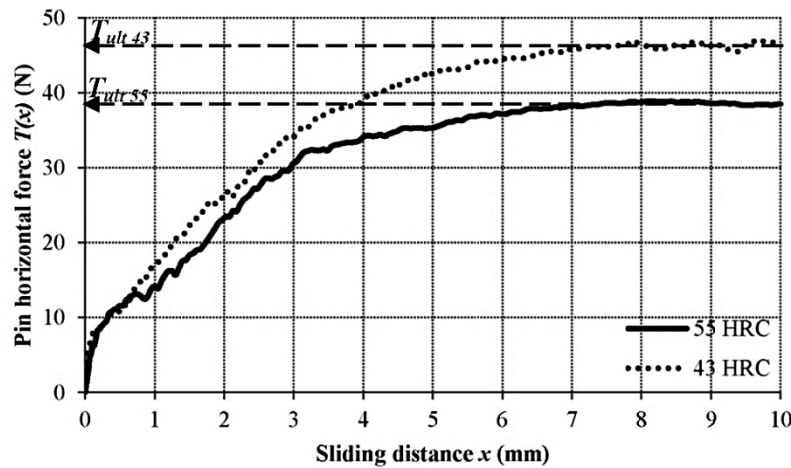

a)

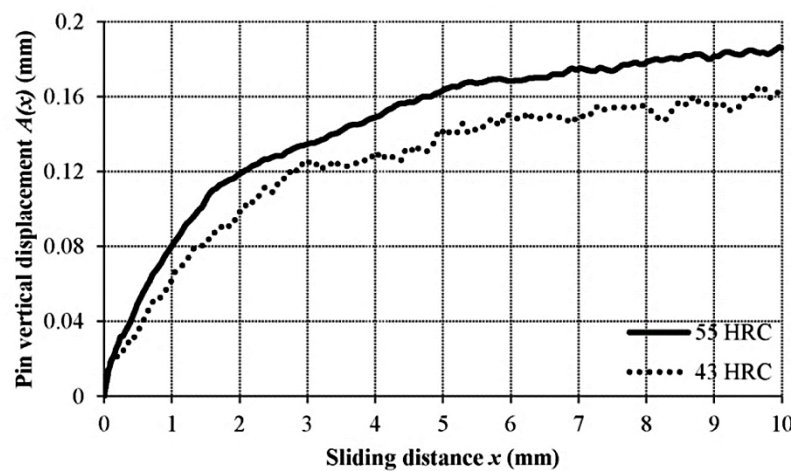

b)

Figure 3. Plots of (a) applied horizontal force on pin, $T(x)$, and determination of T_{ult} , and (b) pin vertical displacement, $A(x)$, versus sliding distance obtained on an andesite sample by 55HRC and 43HRC pins [35].

To investigate the correlations between $MCAI$, AMC , and other mechanical properties of the rock samples, a preliminary statistical analysis was performed, and the results obtained were compared with the same correlations between the CAI and rock properties. These correlations are summarized in Figures 4 and 5 for 55HRC and 43HRC pins, respectively. In both cases, there is no considerable difference between the correlation coefficient of CAI and $MCAI$ with AMC . However, correlations of $MCAI$ with mechanical properties of rock samples are somewhat stronger than the correlations of CAI . This is a logical trend since $MCAI$ has a closer relation to the mechanical properties of the rock samples because it contains the effect of pin tip penetration on the sample surface.

Figures 4 and 5 show that CAI and $MCAI$ have almost the same correlation with the average abrasive hardness of rock samples. However, it has been proven that hardness alone cannot

sufficiently represent rock abrasive properties, and other parameters such as matrix strength and bond strength between the grains and crystals have a considerable effect on the wear of used steel pins [14, 15]. Plinninger et al. have introduced Rock Abrasivity Index (RAI) by multiplying the rock's uniaxial compressive strength (UCS) and equivalent quartz content (EQC) [10]. Moreover, the equations developed to calculate rock cutting forces use shear strength, uniaxial compressive strength, and tensile strength as input parameters [38-41]. A comparison between the $MCAI$ and CAI correlations with uniaxial compressive strengths (UCS) and Brazilian tensile strengths (BTS) reveals that $MCAI$ has stronger correlations with these strength parameters, and it seems to be a better parameter to describe/predict wear of cutting tools. However, more investigations and direct measurements of tool life in field applications are essential to obtain more reasonable conclusions.

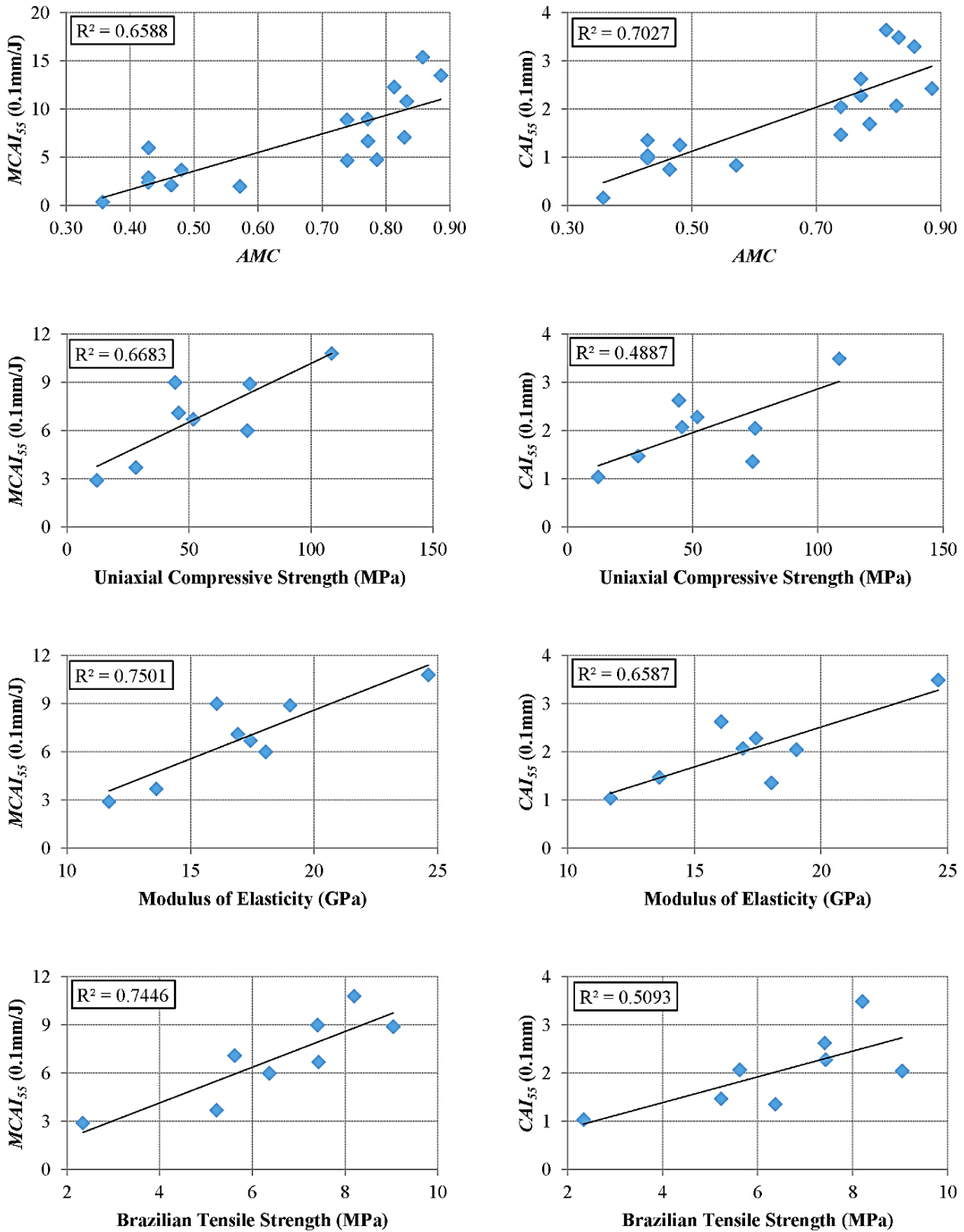

Figure 4. Correlations between $MCAI_{55}/CAI_{55}$ and abrasive mineral content and mechanical properties of samples.

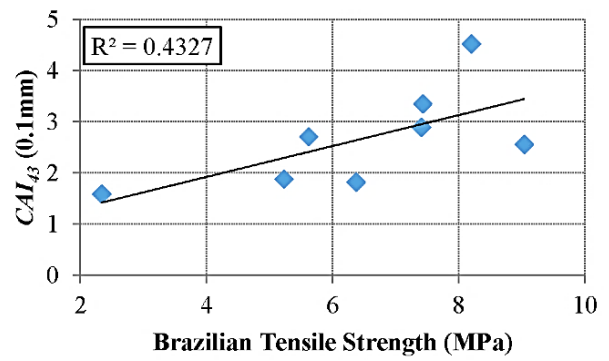
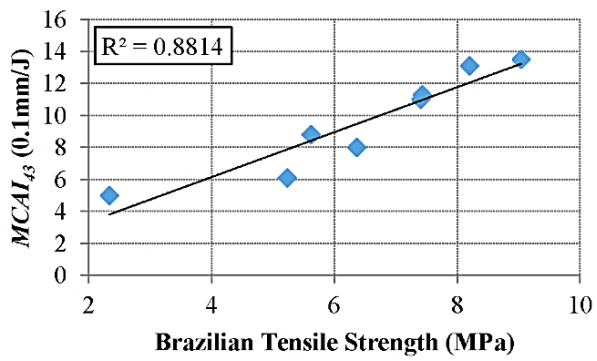
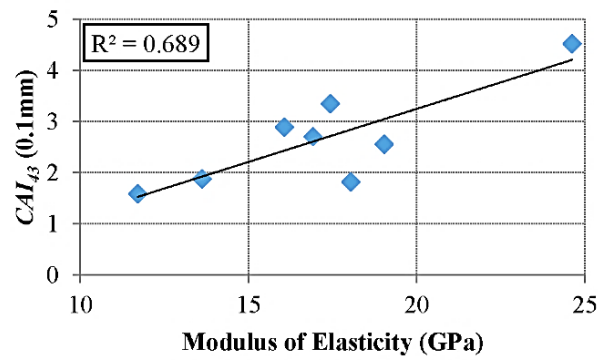
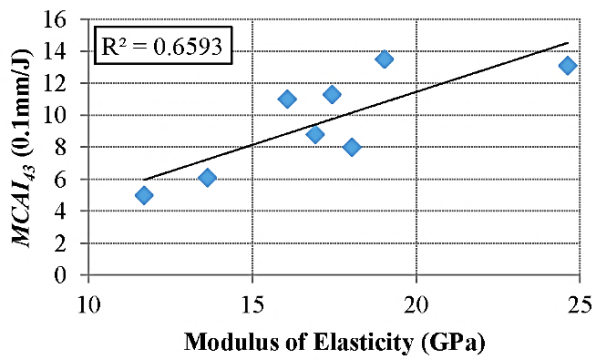
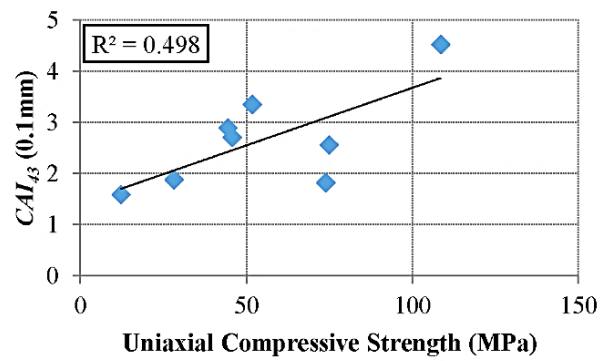
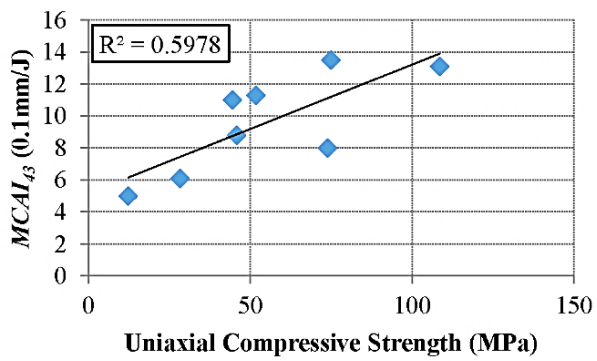
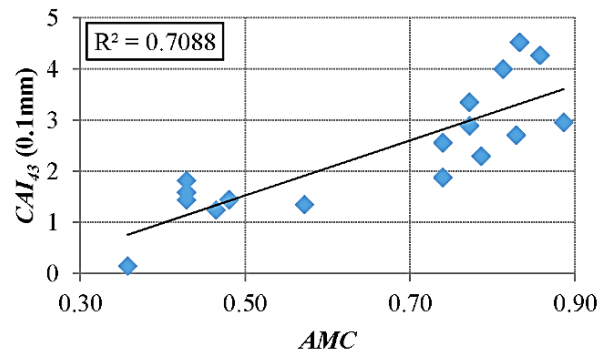
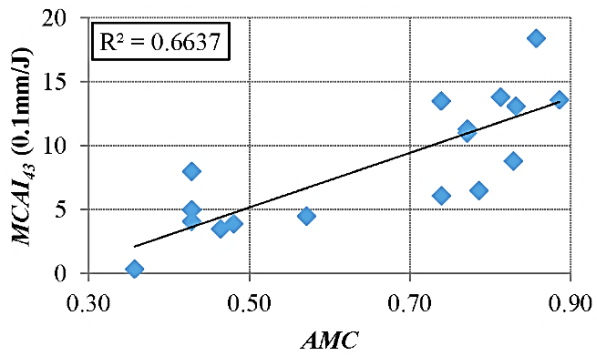

Figure 5. Correlations between MCAI₄₃/CAI₄₃ and abrasive mineral content and mechanical properties of samples.

3.2. Variation of pin tip wear and pin tip penetration along scratch

Values of the applied horizontal force on the pin and its vertical displacement at any point in the sliding path are noted by $T(x)$ and $A(x)$, respectively. x is the distance of the pin from the starting point of the scratch. If the tests are performed on sawn surfaces of rock samples, which are mounted horizontally on the testing device, the relation between pin tip wear, its penetration into the rock surface, and recorded vertical displacement can be obtained as follows [13]:

$$A(x) = P(x) + 0.05CAI(x) \quad (3)$$

The equation was obtained based on the geometry of a pin tip (Figure 6), where $CAI(x)$ and $P(x)$ are the wear of the pin tip and its penetration into the rock surface at the distance x , respectively. $A(x)$ and $P(x)$ in Equation (3) are in mm, and $CAI(x)$ is in 0.1 mm. $A(x)$ is recorded during the test. However, both $CAI(x)$ and $P(x)$ are unknown. Therefore, determination of these parameters requires an extra equation, which can be expressed as follows:

$$P(x) = \frac{2D.T(x)}{(N - T(x))} \quad (4)$$

where N is the normal static force on the pin (= 70 N) and D is the distance of $T(x)$ applying point from the rock surface. If all the tests were to be performed on the sawn surface of a sample on the testing device, D can be considered as a fixed quantity. Details of deriving Equations (3) and (4) and calculation of D have been discussed elsewhere [13].

In order to verify the accuracy of the proposed analytical model, additional Cerchar tests with sliding distances of 5 mm were performed on six rock samples with different CAI values. The results of these tests are shown in Figure 7. In addition, the $CAI(x)$ curves obtained from analytical equations of (3) and (4) are plotted for a sliding length of 10 mm in Figure 7. The bold lines are estimated by the analytical equations, and the points are the results of direct measurements. As it can be seen, the results of 5 mm and 10 mm tests are very close to the predicted values on the curves. The little differences between the measured and calculated values may be due to the errors of microscopic pin tip wear reading process. Thus it can be concluded that the proposed equations can be used to calculate the continuous wear of a pin tip within an acceptable precision.

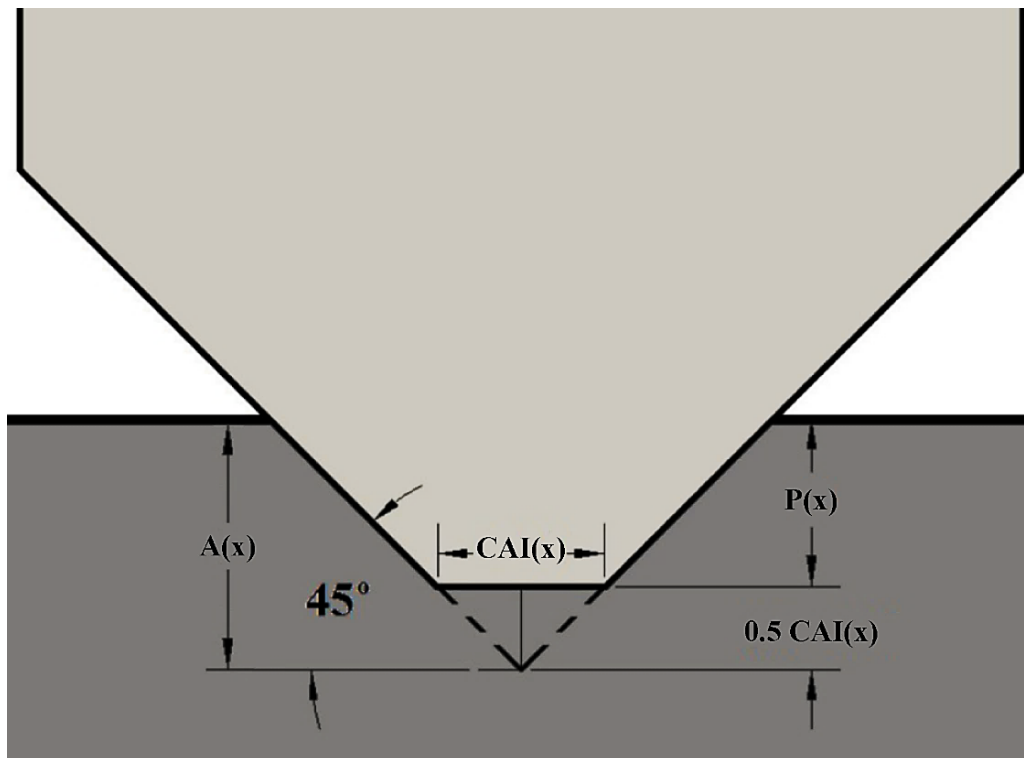

Figure 6. Geometrical relation between pin tip wear ($CAI(x)$), pin tip penetration into rock ($P(x)$), and measured value of vertical displacement sensor ($A(x)$) (not to scale) [13].

3.3. Calculation of scratching energy index

The pin tip wear and its penetration into the rock surface, at any point of sliding path, can be calculated by Equations (3) and (4). It is assumed that the pin tip sides conform to the groove sides, as shown in Figure 8. Hence, the cross-section of the groove can be estimated at any point along the path knowing values of $CAI(x)$ and $P(x)$.

Figure 9 shows some examples of cross-sectional profiles for the four rock samples (UT-09, AR-07, AR-31, and UT-04) being scratched with the 55HRC and 43HRC pins. The cross-sections are plotted at the sliding lengths (x) of 0.5, 1, 2, 5, and 10 mm. If these samples are classified based on the categories defined by the original Cerchar classification [8], in the category of not very abrasive (UT-09 with $CAI_{55} = 0.35$), the width of

groove tip does not change much at the various sliding distances but its depth increases rapidly due to fast penetration of the pin tip into the rock sample. On the other hand, in a very abrasive sample (UT-04 with $CAI_{55} = 3.30$), the depth of the groove is insignificant and constant but its width increases rapidly due to fast wear of the pin tip. In the other samples (AR-07 with $CAI_{55} = 1.26$ and AR-31 with $CAI_{55} = 2.05$), which are classified as medium abrasivity, a combination of two states can be seen, depending on the abrasivity of the rock sample and penetration of the pin tip into the rock surface. Comparing the results of 55HRC and 43HRC pins, it can be seen that in the harder pins, the tip wear is smaller, and its penetration into the rock surface is deeper.

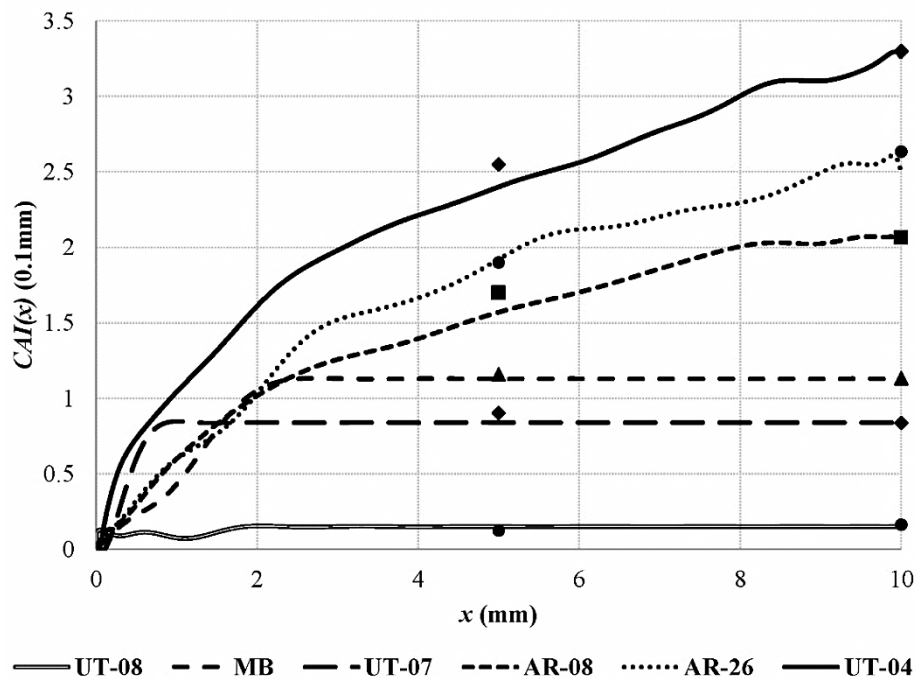

Figure 7. Comparison between results of analytical estimations (curves) and direct measurements (points).

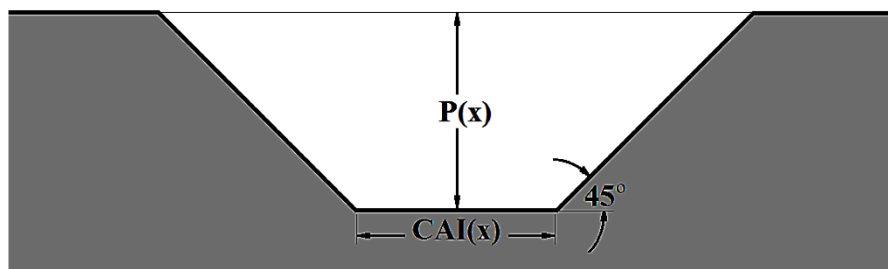

Figure 8. Assumed cross-section of groove as it conforms to pin profile during Cerchar test (not to scale).

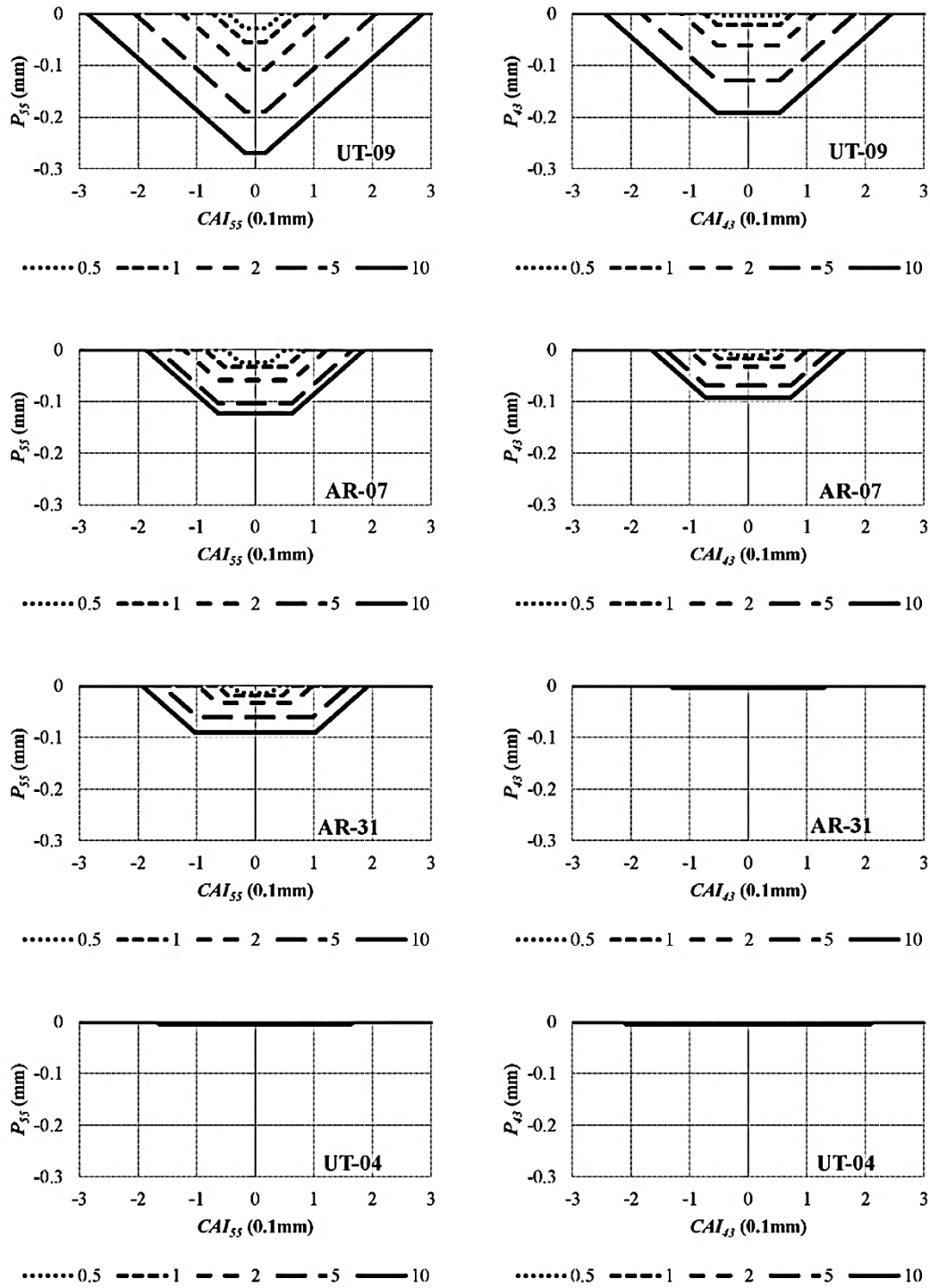

Figure 9. Cross-section of grooves in selected tests on samples with various abrasivity. Cross-sections are calculated for sliding distances of 0.5, 1, 2, 5, and 10 mm.

Often in a rock excavation process, estimating the required energy to excavate (and in this case, to scratch) the unit volume of a rock is a useful measure for comparing various methods of rock breakage. This parameter is called “specific energy” (*SE*), and has an inverse correlation with the efficiency of rock cutting. The theoretical minimum value of energy that is consumed in a fragmentation process is the required surface

energy for creating the new surface areas of the produced fragments. In practice, the magnitude of energy actually used for rock fragmentation is much greater than the theoretical minimum. The actual quantity of energy depends on the type of process and nature of the rock. These factors are not independent [42].

The new device measures the horizontal force, which is required to move the pin on the rock

surface ($T(x)$). According to the physical definition of the work, the area under the force-displacement curve can be considered as the work done or the consumed energy for the movement of the pin. Therefore, the work done during any Cerchar test can be calculated by integration of $T(x)$, as follow:

$$W = \int_0^{l_0} T(x)dx \quad (5)$$

The pin tip wear and its penetration into the rock surface at any point of the sliding path are obtained from the $CAI(x)$ and $P(x)$ calculated values. If the geometry of the created groove assumed in Figure 8 were to be used, the area of excavated section at any point of the sliding path ($S(x)$) can be calculated as follows:

$$S(x) = P(x)[CAI(x) + P(x)] \quad (6)$$

Thus the excavated volume of the sample in a test is calculated using equation (7):

$$V = \int_0^{l_0} S(x)dx = \int_0^{l_0} P(x)[CAI(x) + P(x)]dx \quad (7)$$

and the scratch energy index for the Cerchar test (SE_i) can be calculated from the values of W and V , as follows:

$$SE_i = \frac{W}{V} = \frac{\int_0^{l_0} T(x)dx}{\int_0^{l_0} P(x)[CAI(x) + P(x)]dx} \quad (8)$$

The term “scratch energy index or SE_i ” was selected to avoid confusion with specific energy, often used in a full-scale excavation application since the nature and scale of rock fragmentation in these processes are different.

Using Equation (8), the SE_i values are calculated for all samples. These values are reported in Table 1 along with the CAI and $MCAI$ values for the 43HRC and 55HRC pins. Figure 10 shows the correlation between SE_i and CAI for the 55HRC and 43HRC pins, respectively. In both groups of pins, SE_i increases exponentially with increase in the abrasivity of the rock samples. Statistical analysis of data shows that SE_i can be correlated to CAI by Equations (9) and (10):

$$SE_{i43} = 0.9534e^{0.7270CAI_{43}} \quad R^2 = 0.649 \quad (9)$$

$$SE_{i55} = 0.4641e^{0.9505CAI_{55}} \quad R^2 = 0.8299 \quad (10)$$

where SE_{i43} and SE_{i55} are the scratch energy indices obtained by the 43HRC and 55HRC pins, respectively.

The spread of estimated SE_i values increases with increasing abrasivity, as shown in the charts of Figure 10. As mentioned earlier, with increase in the rock abrasivity, pin penetrates less into the rock, and thus P is very small in the abrasive samples. Therefore, the accuracy of penetration measurements decreases due to the limited resolution of measuring sensors for vertical displacement. This leads to a higher spread of calculating values in more abrasive samples. In addition, in the more abrasive samples, the pin tends to slip on the surface of the rock sample rather than penetrate into it, which again can influence the accuracy of the recorded force and calculated energy. Variation in the results of SE_i calculations for the pins with 43HRC hardness is also greater than that of the 55HRC pins. This is again due to the low penetration of the softer pins into the rock samples and the higher probability of slipping on the sample surfaces.

Figure 11 shows the correlations between SE_i and the abrasive mineral content (AMC), uniaxial compressive strength (UCS), modulus of elasticity (E), and Brazilian tensile strength (BTS). The correlation coefficient for the best fit curves in this Figure is lower than the graphs in Figure 10. The best fit lines and the correlations of SE_i with UCS , E , and BTS are linear. This could be due to the lower number of available data points in Figure 11. However, the trends seem reasonable. SE_i shows an increasing trend in all graphs. This means that increasing the sample hardness and strength properties increases the required specific energy to scratch the sample surface. Furthermore, all of the fitted trends on SE_{i43} values are thoroughly located above SE_{i55} trends. In other words, making a scratch by a softer pin always takes more energy. The difference between the gradients of fitted trends on the 43HRC and 55HRC pin data is another important point in the graphs shown in Figure 11. The trends obtained by the 43HRC pins have steeper gradients than the trends relevant to the harder pins. This means that increasing AMC , UCS , E , and BTS causes a greater increase in the consumed specific energy for the softer pins and the difference between the SE_i of 43HRC, and the 55HRC pins increase with increase in the sample hardness and mechanical strength. This can confirm that in the softer and weaker rock types, increasing the cutting tool hardness may not be as critical, and it does not cause a considerable improvement in the efficiency of the cutting process. This is reflected in the curves in Figure 11, which shows closing

the SE_i trend lines in the lower range of hardness and rock mechanical strength.

Despite the best fit trends on the SE_i - AMC plot that have an exponential form, the difference between the $SE_{i\ 43}$ and $SE_{i\ 55}$ trends at the high values of AMC is not so great. The greatest difference between the scratch energy index trends of the 43HRC and 55HRC pins at the high values of horizontal axes is evident in the SE_i - BTS graphs, meaning that increasing BTS causes a larger difference between the required scratch energy index of soft and hard pins. It seems like the tensile strength is the most important and determinant factor in the required hardness of the

rock cutting tools from the viewpoint of specific energy. However, the few count of data points and the low quality of fitted trends may affect the results, and more tests are required to reach an overall conclusion.

In Figure 12, the SE_i values are shown versus $MCAI$ for pins of 55 and 43 HRC. Comparing the R^2 values of fitted curves with the SE_i - CAI curves (Figure 10) reveals that the R^2 values show a minor increase in the SE_i - $MCAI$ curves. This means that SE_i has a closer correlation to $MCAI$ because it includes the effect of pin penetration into the rock as well as its tip wear [35].

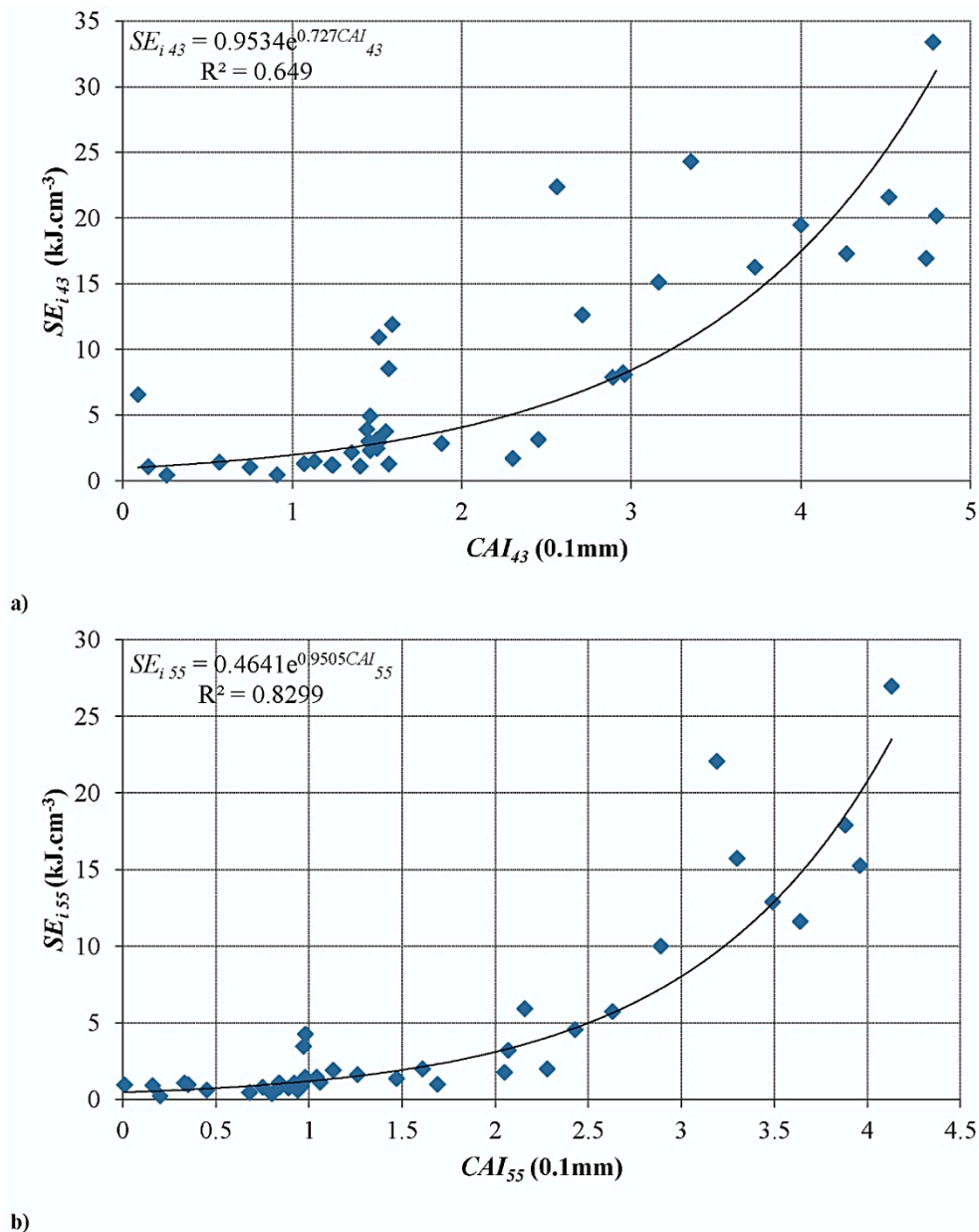

Figure 10. Scratch energy index (SE_i) versus Cerchar abrasion index (CAI) for pins with hardness of a) 43 HRC and b) 55 HRC.

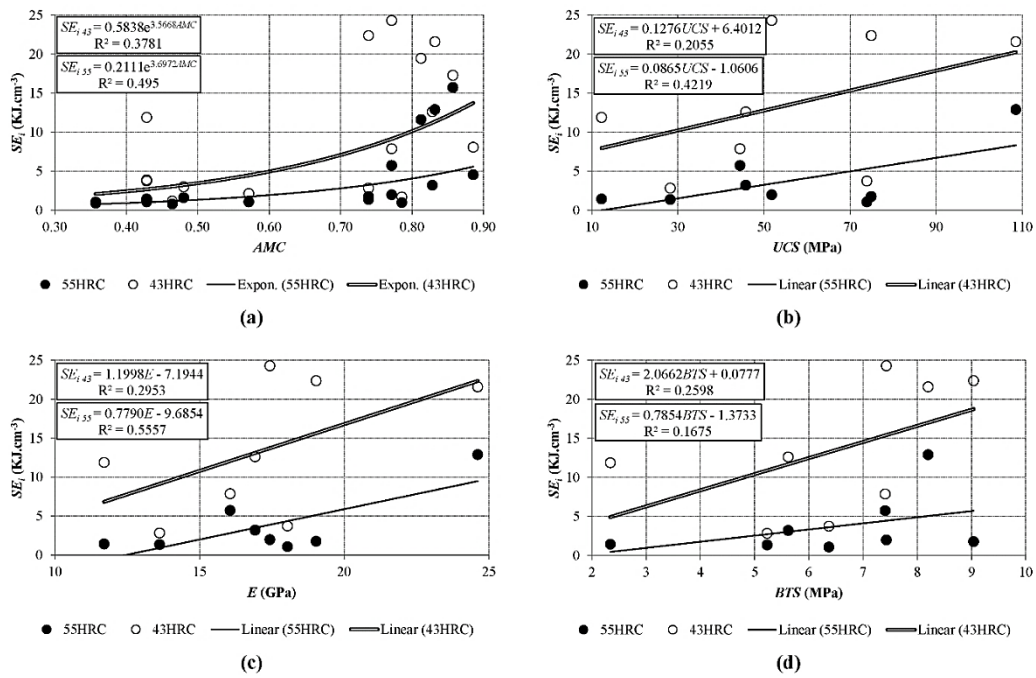

Figure 11. Correlations of scratch energy index (SE_i) with a) abrasive mineral contents (AMC), b) uniaxial compressive strength (UCS), c) modulus of elasticity (E), and d) Brazilian tensile strength (BTS) for 43HRC and 55HRC pins.

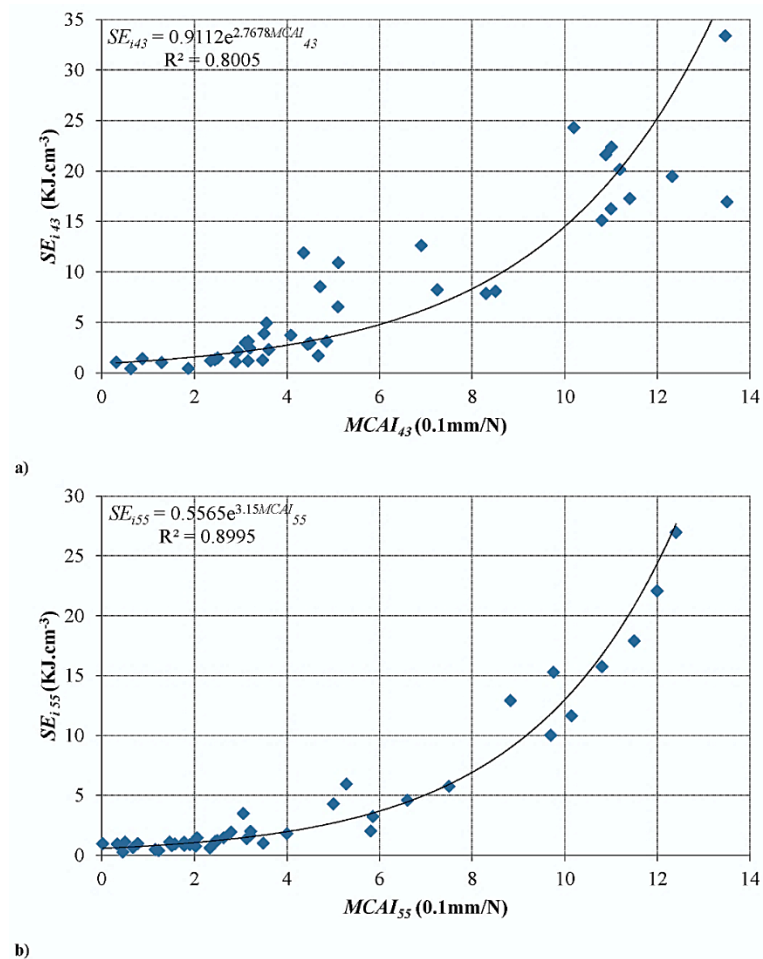

Figure 12. Scratch energy index (SE_i) versus Cerchar abrasion index (CAI) for pins with hardness of a) 43 HRC and b) 55 HRC.

4. Conclusions

The current work is based upon the results of the Cerchar abrasivity tests with a new device that could accurately control test variables such as the sliding length and the pin moving velocity, while offering continuous measurement of the required force for scratching and vertical displacements of the pin. The results obtained show that:

- The introduced modified Cerchar abrasion index (*MCAI*) includes the effect of pin tip penetration into the rock surface, and has better correlations with the rock mechanical parameters of *UCS*, *BTS*, and *E*. These mechanical parameters are effective on the wear rate of rock cutting tools, and it seems like *MCAI* is more suitable for describing the abrasive behavior of rock samples than *CAI*.

- The proposed analytical method used to calculate instantaneous values of pin tip wear and its penetration into the rock surface has an acceptable accuracy, and could be used to describe the interaction between the steel pins and rock samples.

- Using the available data by a new testing device and proposed analytical equations, a method was proposed to calculate the specific energy of scratch as scratch energy index (SE_i).

- SE_i showed exponential correlations with *CAI*, *MCAI*, and *AMC*. However, correlations with the mechanical parameters *UCS*, *BTS*, and *E* were linear.

- SE_i could provide a basis to compare the efficiency of scratching rock surface (and perhaps cutting tools) with different pin hardness values. It could also be used to estimate the specific energy reduction resulting from hardness increase of the applied pins.

- *MCAI* has better correlations with SE_i values than *CAI*. This is due to the inclusion of rock strength properties in calculation of *MCAI*'s.

- The ability of *MCAI* and SE_i in offering better correlation with tool consumption in the field while promising, requires more studies by comparing these parameters with recorded cutting tool life on various machines and project settings. There is also a need to examine the correlation between *MCAI* and SE_i with other rock properties in a wider range of rock samples in the future investigations.

Acknowledgments

The authors would like to express their gratitude to Mr. Reza Sanajian and Mrs. Mahdiah Nasiri in

Folowrd Industrial Plans Co. for their unsparing technical supports in designing and manufacturing of the testing device. Also the authors wish to express their appreciation to Iran Water & Power Resources Development Co., Mr. Banihashemi of Mahab Ghods Consultant Engineers Co., and Mr. Mahinraad of Moshanir Consultant Engineers Co. for providing the samples used in testing and additional information necessary to conduct experiments and subsequent analysis.

References

- [1]. Zum Gahr, K.H. (1987). Microstructure and wear of materials. Amsterdam. Elsevier. 559 P.
- [2]. Verhoef, P.N.W. (1997). Wear of rock cutting tools. Rotterdam. Balkema. 340 P.
- [3]. CERCHAR. (1973). Cerchar tests for the measurement of hardness and abrasivity of rocks. French Coal Industry: Centre Study Research, Document. 73-59: 1-10.
- [4]. AFNOR. (2000). De'termination du pouvoir abrasive d'une roche- Partie 1: Essai de rayure avec une pointe (NF P 94-430-1). Paris.
- [5]. ASTM D7625-10. (2010). Standard test method for laboratory determination of abrasiveness of rock using the CERCHAR method. ASTM International.
- [6]. Alber, M., Yarali, O., Dahl, F., Bruland, A., Kasling, H., Michalakopolous, T.N., Cardu, M., Hagan, P. and Aydin, H. (2014). ISRM suggested method for determining the abrasivity of rock by the CERCHAR abrasivity test. Rock Mech Rock Eng. 47: 261-266.
- [7]. Rostami, J., Ozdemir, L., Bruland, A. and Dahl, F. (2005). Review of issues related to Cerchar Abrasivity testing and their implications on geotechnical investigations and cutter cost estimates. Proc, Rapid excavation and tunneling conference (RETC). Seattle. pp. 738-751.
- [8]. CERCHAR- Centre d' Etudes et Recherches de Charbonnages de France. (1986). The CERCHAR abrasiveness index. 12 S., Verneuil.
- [9]. Bieniawski, Z.T., Celada, B., Galera, J.M. and Tardagiula, I. (2009). Prediction of cutter wear using RME. Proc, ITA Congress. Budapest.
- [10]. Plinninger, R.J., Kasling, H. and Thuro, K. (2004). Wear prediction in hard rock excavation using the Cerchar abrasiveness index (CAI). Proc, ISRM regional Symposium EUROCK 2004 & 53rd Geomechanics Colloquy. Salzburg. pp. 599-604.
- [11]. Yarali, O., Yasar, E., Bacak, G. and Ranjith, P.G. (2008). A study of rock abrasivity and tool wear in coal measures rocks. Int J Coal Geol. 74: 53-66.
- [12]. Girmscheid, G. (2000). Construction management and construction techniques in tunneling. Berlin. Ernst and Sohn.

- [13]. Hamzaban, M.T., Memarian, H. and Rostami, J. (2014). Continuous monitoring of pin tip wear and penetration into rock surface using a new Cerchar abrasivity testing device. *Rock Mech Rock Eng.* 47: 689-701.
- [14]. Suana, M. and Peters, T. (1982). The Cerchar abrasivity index and its relation to rock mineralogy and petrography. *Rock Mech Rock Eng.* 15: 1-7.
- [15]. West, G. (1989). Rock abrasiveness testing for tunneling. *Int J Rock Mech Min Sci.* 26: 151-160.
- [16]. Al-Ameen, S.I. and Waller, M.D. (1994). The influence of rock strength and abrasive mineral content on the Cerchar abrasive index. *Eng Geol.* 36: 293-301.
- [17]. Plinninger, R.J., Kasling, H., Thuro, K. and Spaun, G. (2003). Testing conditions and geomechanical properties influencing the cerchar abrasivity index (CAI) value. *Int J Rock Mech Min Sci.* 40: 259-263.
- [18]. He, J., Li, S., Li, X., Wang, X. and Guo, J. (2016). Study on the correlations between abrasiveness and mechanical properties of rocks combining with the microstructure characteristic. *Rock Mech Rock Eng.* 49: 2945-2951.
- [19]. Cheshomi, A. and Moradhaseli, S. (2017). Effect of petrographic characteristics on abrasive properties of granitic building stones. *Quarterly Journal of Engineering Geology and Hydrogeology.* 2016-2048.
- [20]. Yarali, O. (2017). Investigation into Relationships Between Cerchar Hardness Index and Some Mechanical Properties of Coal Measure Rocks. *Geotechnical and Geological Engineering.* 35: 1605-1614.
- [21]. Capik, M. and Yilmaz, A.O. (2017). Correlation between Cerchar abrasivity index, rock properties, and drill bit lifetime. *Arabian Journal of Geosciences.* 10: 1-12.
- [22]. Jager, W. (1988). An investigation into the abrasive capacity of rocks. In: *Memoirs of the Centre of Engineering Geology in the Netherlands.* Delft University of Technology. 52: 99.
- [23]. Reinking, M.W. (1989). Linear cutting tests in artificial sand-clay mixtures to study the influence of brittleness on abrasive wear of cutting tools. In: *Memoirs of the Centre of Engineering Geology in the Netherlands.* Delft University of Technology. 75: 95.
- [24]. Deketh, H.J.R. (1995). Wear of the cutting tools of rock excavation machines. *Proc. 35th US symposium of Rock Mechanics.* Reno. pp. 342-347.
- [25]. Kahraman, S., Alber, M., Fener, M. and Gunaydin, O. (2010). The usability of Cerchar abrasivity index for the prediction of UCS and E of Misis Fault Breccia: Regression and artificial neural network analysis. *Expert Systems with Applications.* 37: 8750-8756.
- [26]. Khandelwal, M. and Ranjith, P.G. (2010). Correlating index properties of rocks with P-Wave measurements. *Journal of Applied Geophysics.* 71: 1-5.
- [27]. Deliormanli, A.H. (2012). Cerchar abrasivity index (CAI) and its relation to strength and abrasion test methods for marble stones. *Construction and Building Materials.* 30: 16-21.
- [28]. Alber, M. (2008). Stress dependency of the Cerchar abrasivity index (CAI) and its effects on wear of selected rock cutting tools. *Tunn Und Space Tech.* 23: 351-359.
- [29]. Büchi, E., Mathier, J.F. and Wyss, C.H. (1995). Rock abrasivity- a significant cost factor for mechanical tunneling in loose and hard rock. *Tunnel.* 95: 38-44.
- [30]. Michalakopolous, T.N., Anagnostou, V.G., Bassanou, M.E. and Panagiotou, G.N. (2006). The influence of styli hardness on the Cerchar abrasiveness index value. *Int J Rock Mech Min Sci.* 43: 321-327.
- [31]. Rostami, J., Ghasemi, A., Alavi, E., Dogruoz, C. and Dahl, F. (2014). Study of dominant factors affecting Cerchar abrasivity index. *Rock Mech Rock Eng.* 47: 1905-1919.
- [32]. Majeed, Y. and Abu Bakar, M.Z. (2016). Statistical evaluation of CERCHAR abrasivity index (CAI) measurement methods and dependence on petrographic and mechanical properties of selected rocks of Pakistan. *Bull Eng Geol Environ.* 75: 1341-1360.
- [33]. Yarali, O. and Duru, H. (2016). Investigation into effect of scratch length and surface condition on Cerchar abrasivity index. *Tunn Und Space Tech.* 60: 111-120.
- [34]. Bakar, M.A., Majeed, Y. and Rostami, J. (2016). Effects of rock water content on CERCHAR Abrasivity Index. *Wear.* 368: 132-145.
- [35]. Hamzaban, M.T., Memarian, H., Rostami, J. and Ghasemi, H. (2014). Study of rock-pin interaction in Cerchar abrasivity test. *Int J of Rock Mech & Min Sci.* 72: 100-108.
- [36]. Sotoudeh, F., Memarian, H., Hamzaban, M.T. and Rostami, J. (2014). Improvement of testing accuracy by a new generation of Cerchar abrasivity testing device. *Proc. North American Tunneling.* Los Angles. pp. 211-217.
- [37]. Thuro, K. (1996). Drillability prediction-geological influences in hard rock drill and blast tunneling. *Geol Rundsch.* 426-437.
- [38]. Evans, I. (1970). Relative efficiency of picks and disks for cutting rock. *Proc. 3rd congress on Advances in Rock Mechanics.* pp. 1399-1405.
- [39]. Roxborough, F.F. and Philips, H.R. (1975). Rock excavation by disk cutters. *Int J of Rock Mech & Min Sci.* 12: 361-366.

[40]. Snowden, R.A., Ryley, M.D. and Temporal, J. (1982). A study of disk cutting in selected British rocks. *Int J of Rock Mech & Min Sci.* 19: 107-121.

[41]. Lindqvist, P.E. and Ranman, K.E. (1980). Mechanical rock fragmentation chipping under a disk cutter. University of Lulea. Lulea. Sweden. Technical Report.

[42]. Hood, M.C. and Roxborough, F.F. (1992). Rock Breakage: Mechanical. In: Hartman, H.L., Britton, S.G., Mutmanský, J.M., Gentry, D.W., Schlitt, W.J., Karims, M., Singh, M.M., eds. *SME Mining Engineering Handbook*. Colorado, Society for Mining, Metallurgy, and Exploration, Inc. pp. 680-721.

تعیین اندیس انرژی خراش برای آزمون سایش سیرشار

محمد تقی همزبان^{*}، حسین معاریان^۲ و جمال رستمی^۳

۱- بخش مهندسی معدن، دانشگاه صنعتی سهند، ایران

۲- بخش مهندسی معدن، دانشکده فنی و مهندسی، دانشگاه تهران، ایران

۳- بخش مهندسی معدن، مدرسه معدنی کلرادو، ایالات متحده آمریکا

ارسال ۲۰۱۷/۵/۲۳، پذیرش ۲۰۱۷/۷/۲۷

* نویسنده مسئول مکاتبات: hamzaban@sut.ac.ir

چکیده:

خراشندگی سنگ، عاملی اساسی در انتخاب ابزارهای برنده، تخمین سایش و عمر مفید ابزارها و در نهایت، انطباق سیستم‌های حفاری مکانیزه، با شرایط زمین‌شناسی موجود است. این ویژگی، به عنوان راهنمایی در تعیین محدودیت‌های اقتصادی ابزارهای برنده و ماشین‌آلات مختلف، در پروژه‌های عمرانی و معدنی، مورد استفاده قرار می‌گیرد. آزمون سایش سیرشار، روشی ساده است که امروزه به صورت گسترده برای ارزیابی قدرت خراشندگی سنگ‌ها به کار می‌رود. با این حال، این آزمایش، محدودیت‌هایی نیز در توصیف برهم‌کنش سنگ- فولاد، در طول فرآیند حفاری دارد. در این مطالعه، از دو پارامتر جدید برای توصیف برهم‌کنش میان پین و سنگ و ارزیابی کارایی فرآیند ایجاد خراش در آزمون سایش سیرشار، استفاده شده است. مجموعه‌ای از ۴۱ نمونه سنگی مختلف، با استفاده از یک دستگاه جدید، مورد آزمایش قرار گرفت. دستگاه توسعه یافته جدید، امکان کنترل دقیق‌تر پارامترهای عملیاتی آزمایش را همراه با اندازه‌گیری نیروی اصطکاکی اعمال شده به پین و جابجایی قائم و افقی آن روی سطح نمونه، فراهم می‌کند. با استفاده از نتایج به دست آمده، اندیس سایش سیرشار اصلاح شده (MCAI) و اندیس انرژی خراش (SE_i) به عنوان پارامترهایی جدید، محاسبه شدند. دقت پارامترهای محاسبه شده مورد بحث قرار گرفت و نتایج نشان دادند که همبستگی MCAI با پارامترهای مکانیکی سنگ، بهتر از همبستگی اندیس سایش سیرشار (CAI) با این پارامترها است؛ بنابراین، MCAI پتانسیل بالاتری در تخمین سایش ابزارهای برنده مورد استفاده در حفر تونل‌ها دارد. SE_i نیز همبستگی‌های قابل قبولی با سختی نمونه‌های سنگی و ویژگی‌های مکانیکی آن‌ها به نمایش گذاشت. نتایج نشان دادند که می‌توان از SE_i برای مقایسه کارایی پین‌هایی با سختی مختلف، در ایجاد خراش روی نمونه‌های سنگی گوناگون استفاده کرد و از آن به نوان پارامتری تعیین کننده در انتخاب سختی ابزارهای برنده، در شرایط مختلف، بهره برد.

کلمات کلیدی: آزمون سایش سیرشار، اندیس انرژی خراش، خراشندگی سنگ، سایش ابزار حفاری.